



SubDrive75/100/150/300/2W MonoDrive, MonoDriveXT Constant Pressure Controller Installation Manual

Before Getting Started

⚠ WARNING

Serious or fatal electrical shock may result from failure to connect the ground terminal to the motor, SubDrive/MonoDrive controller, metal plumbing, or other metal near the motor or cable, using wire no smaller than motor cable wires. To minimize risk of electrical shock, disconnect power before working on or around the SubDrive/MonoDrive system. CAPACITORS INSIDE THE SUBDRIVE/MONODRIVE CONTROLLER CAN STILL HOLD LETHAL VOLTAGE EVEN AFTER POWER HAS BEEN DISCONNECTED.

ALLOW 5 MINUTES FOR DANGEROUS INTERNAL VOLTAGE TO DISCHARGE BEFORE REMOVING SUBDRIVE/MONODRIVE COVER.

Do not use motor in swimming areas.

⚠ ATTENTION

This equipment should be installed by technically qualified personnel. Failure to install it in compliance with national and local electrical codes and within Franklin Electric recommendations may result in electrical shock or fire hazard, unsatisfactory performance, or equipment failure. Installation information is available through pump manufacturers and distributors, or directly from Franklin Electric at our toll-free number 1-800-348-2420.

⚠ CAUTION

Use SubDrive/MonoDrive only with Franklin Electric 4-inch submersible motors as specified in this manual (see Table 1, pg. 4). Use of this unit with any other Franklin Electric motor or with motors from other manufacturers may result in damage to both motor and electronics.

Contents

Declaration of Conformity	4
Description and Features	5
Included Items	6
How It Works	7-8
Pump Sizing and Drive Configuration	
• SubDrive75	9
• SubDrive100	10
• SubDrive150	11
• SubDrive300	12
• SubDrive2W	13
• MonoDrive	14
• MonoDriveXT	15
Underload Sensitivity for Deep Wells	16-18
Steady Flow Selection	19
Sleep Mode	20
Underload Smart Reset	20
Over Temperature Foldback	20
System Run Relay - SubDrive300 (SubDrive2W)	21
Generator Sizing	22
Controller Location Selection	22-23
Quick Reference Guide	24-27
Circuit Breaker and Wire Sizing	28
Pressure Tank	29
Installation Procedure	30
Wiring Connections	31-33
Special Instructions for Outdoor Installation	34
Strain Relief Installation Guide	35
Start-Up and Operation	36
Specifications	
• MonoDrive	37
• MonoDriveXT	37
• SubDrive75	38
• SubDrive100	38
• SubDrive150	39
• SubDrive300	39
• SubDrive2W	40
Mounting Dimensions	41-43
Accessories	44
Diagnostic Fault Codes	Back Cover
System Troubleshooting Guide	Back Cover

Tables

1. SubDrive and MonoDrive Models	4
2. Circuit Breaker and Wire Sizing	28
3. Maximum Cable Length	28
4. Minimum Pressure Tank Size	29
5. Pressure Tank Pre-charge	29
6. Minimum Pipe Diameter	29

Figures

1. Smart Reset Well Recovery Time	20
2. Shipping / Mounting / Lid Screws	30
3. Motor Lead Connections	31
4. Power and Pressure Sensor Connections	32
5. Pressure Sensor / Pressure Shut-off Sensor	33

SubDrive/MonoDrive

Table 1: SubDrive and MonoDrive Models

Model Name	Part Number	Use with Motor Series
SubDrive75	5870203380 (NEMA 1)	234 514 xxxx (1.5 hp (1.1 kW))
	5870203384 (NEMA 4)	
SubDrive100	5870204100 (NEMA 1)	234 315 xxxx (2.0 hp (1.5 kW))
	5870204104 (NEMA 4)	
SubDrive150	5870204150 (NEMA 1)	234 316 xxxx (3.0 hp (2.2 kW))
	5870204154 (NEMA 4)	
SubDrive300	5870206300 (NEMA 4)	234 317 xxxx (5.0 hp (3.7 kW))
SubDrive2W	5870203223 (NEMA 3R)	244 505 xxxx (1/2 hp (0.37 kW))
		244 507 xxxx (3/4 hp (0.55 kW))
		244 508 xxxx (1.0 hp (0.75 kW))
MonoDrive	5870203110 (NEMA 1)	214 505 xxxx (1/2 hp (0.37 kW))
		214 507 xxxx (3/4 hp (0.55 kW))
	5870203114 (NEMA 4)	214 508 xxxx (1.0 hp (0.75 kW))
MonoDriveXT	5870204110 (NEMA 1)	224 300 xxxx (1.5 hp (1.1 kW))
	5870204114 (NEMA 4)	224 301 xxxx (2.0 hp (1.5 kW))

Declaration of Conformity

Franklin Electric declares under our sole responsibility, all SubDrive/MonoDrive series 587 020 3xx0 controllers are in conformity with the Council Directives on the approximation to the laws of the EEC member states relating to the following:

- Electromagnetic Compatibility (89/336/EEC): Adjustable Speed Electrical Power Drive Systems: Standard EN61800-3
- Low-Voltage Electrical Safety (73/23/EEC) (amending 93/68/EEC): Safety of Household and Similar Electrical Appliances: Standard EN60335-1



Description and Features



The Franklin Electric SubDrive/MonoDrive is a dependable residential water system controller that uses advanced electronics to enhance the performance of standard submersible pumps. When used with the specified Franklin Electric motor (see Table 1, pg. 4), the SubDrive/MonoDrive eliminates pressure cycling associated with conventional water well systems and owners of private water well systems can enjoy “city-like” water pressure.

In addition, the reduced tank size (see Table 4, pg. 29) allows installation in small spaces.

SubDrive/MonoDrive Key Features:

- Constant water pressure with a wide range of settings (25-80 psi) (1.7-5.4 bar)
- Smaller pressure tank can be used
- Fits the pump to the application – pump speed is controlled to provide the optimum performance without overloading the motor
- Flexibility – this unit can be used with standard off-the-shelf pumps
- No in-rush (power-on transient) current
- Low motor start-up current (soft-starting)
- Active Power Factor Correction minimizes input RMS current

Protection Features:

- Dry well conditions – with smart pump monitoring (see Figure 1, pg. 20)
- Bound pump – with auto-reversing torque
- High voltage / lightning surge
- Low line voltage
- Open motor circuit
- Short circuit

SubDrive/MonoDrive

Included Items (NEMA 1) SubDrive75/100/150 MonoDrive/MonoDriveXT

- A. Controller Unit
- B. Strain Relief Fittings
- C. Pressure Sensor and Boot
- D. Sensor Adjustment Tool
- E. Sensor Cable
- F. Installation Guide

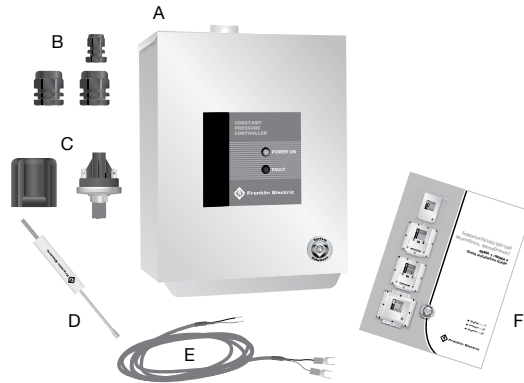

Included Items (NEMA 4) SubDrive75/100/150 MonoDrive/MonoDriveXT

- A. Controller Unit
- B. Pot Adjustment Screw Driver
- C. Pressure Sensor and Boot
- D. Sensor Adjustment Tool
- E. Sensor Cable
- F. Installation Guide
- G. Access Cover

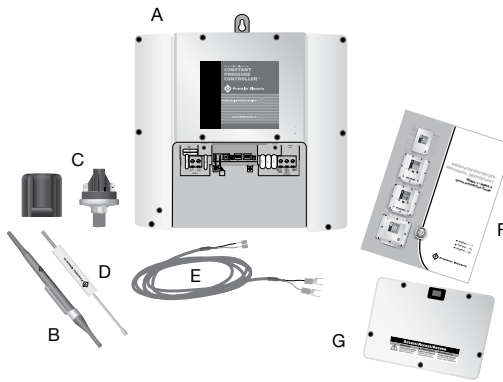

Included Items (NEMA 4) SubDrive300

- A. Controller Unit
- B. Pot Adjustment Screw Driver
- C. Pressure Sensor and Boot
- D. Sensor Adjustment Tool
- E. Sensor Cable
- F. Installation Guide
- G. Strain Relief Fittings
- H. Pressure Shut-off Switch and Boot

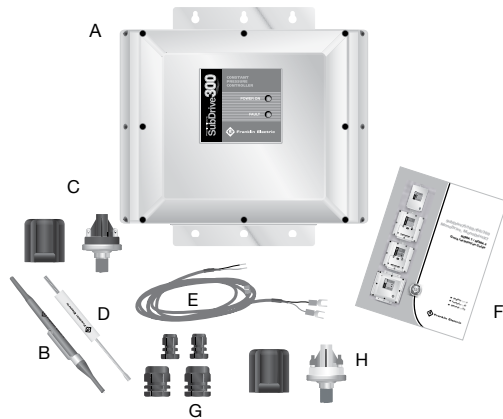

Included Items (NEMA 3R) SubDrive2W

- A. Controller Unit
- B. Pressure Sensor and Boot
- C. Sensor Adjustment Tool
- D. Sensor Cable
- E. Installation Guide

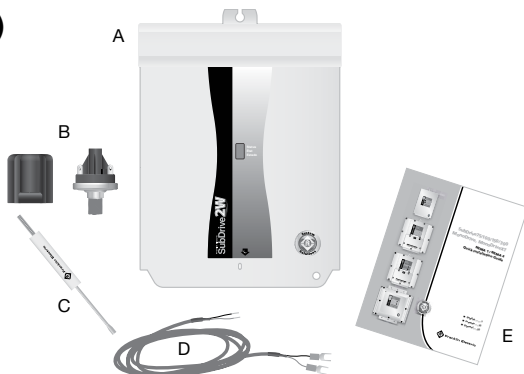

How it Works

The Franklin Electric SubDrive/MonoDrive is designed to be part of a system that consists of only four components:

- A. Standard Pump and Franklin Electric Motor
- B. SubDrive/MonoDrive Controller
- C. Small Pressure Tank (see Table 4, pg. 29)
- D. Franklin Electric Pressure Sensor (NSF 61 rated (provided))
- E. Pressure shut-off switch (NSF 61 rated (SubDrive300 only))

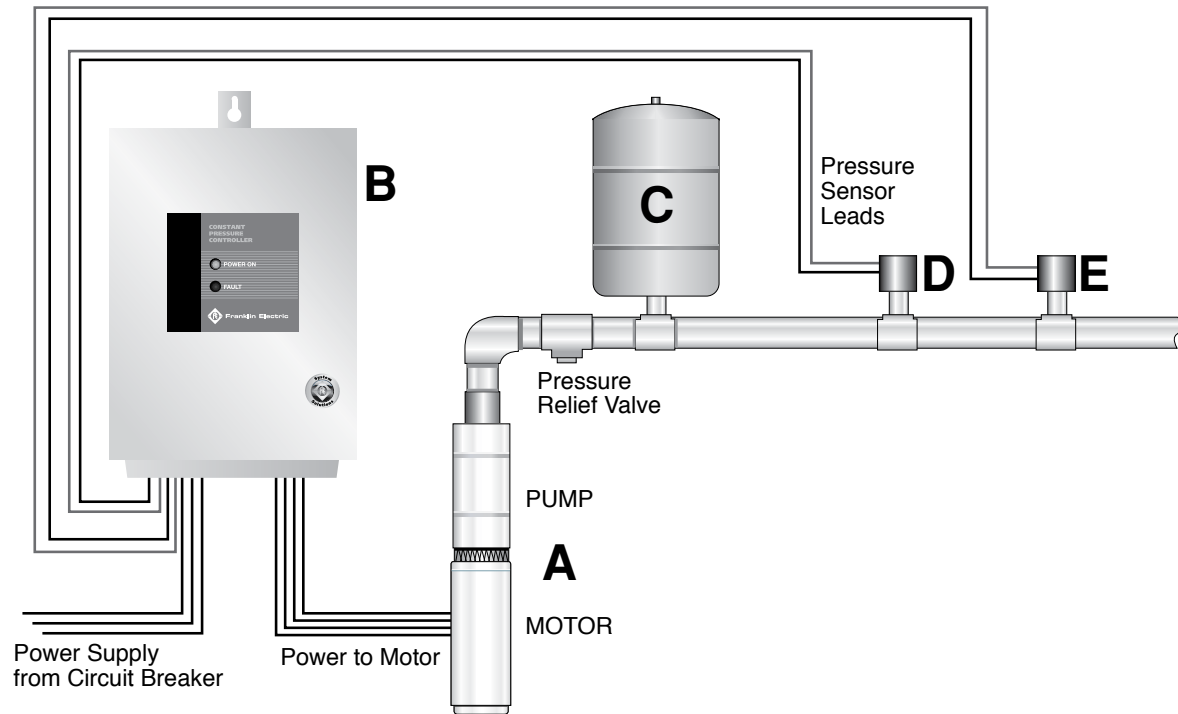

Constant Pressure

The Franklin Electric SubDrive/MonoDrive provides consistent pressure regulation using advanced electronics to drive a standard motor and pump according to the pressure demands indicated by a highly accurate, heavy-duty, long-life pressure sensor. By adjusting the motor/pump speed, the SubDrive/MonoDrive can deliver constant pressure dependably, even as water demand changes. For example, a small demand on the system, such as a bathroom faucet, results in the motor/pump running at a relatively low speed. As greater demands are placed on the system, such as opening additional faucets or using appliances, the speed increases accordingly to maintain the desired system pressure.

SubDrive/MonoDrive

Motor Soft-Start

Normally, when there is a demand for water, the SubDrive/MonoDrive will be operating to accurately maintain system pressure. Whenever the SubDrive/MonoDrive detects that water is being used, the controller always “ramps up” the motor speed while gradually increasing voltage, resulting in a cooler motor and lower start-up current compared to conventional water systems. In those cases where the demand for water is small, the system may cycle on and off at low speed. Due to the controller’s soft-start feature and the sensor’s robust design, this will not harm the motor or the pressure sensor.

System Diagnostics

In addition to regulating pump pressure and accurately controlling motor operation, the SubDrive/MonoDrive continuously monitors system performance and can detect a variety of abnormal conditions. In many cases, the controller will compensate as needed to maintain continuous system operation. But if there is high risk of equipment damage, the controller will protect the system and display the fault condition. If possible, the controller will try to restart itself when the fault condition subsides.

SubDrive vs. MonoDrive

SubDrive controllers provide the ultimate in system performance, utilizing Franklin Electric’s three-phase motor series for maximum starting torque, high efficiency and smooth operation. SubDrives convert residential single-phase 60 Hz power into the variable-frequency three-phase needed by the motor. In addition, SubDrives can spin a smaller pump slightly faster to boost output to roughly double its 60 Hz horsepower rating. This allows use of smaller pumps for less system cost. If a smaller pump of the desired flow rating is not available, the controller can be configured to use larger pumps up to the horsepower rating of the motor.

SubDrive2W controllers are ideal for retrofit applications where a single-phase 2-wire pump system is already installed and in good operating condition. SubDrive2W provides the same features as the MonoDrives. A retrofit is as easy as replacing the existing pressure switch with a MonoDrive and a pressure sensor. If the existing pump, motor and pressure tank are in good working order, no further changes are needed.

MonoDrive controllers are ideal whenever the Franklin Electric single-phase 3-wire series motor is preferred. MonoDrives are especially suited for retrofit applications where a 3-wire pump system is already installed and in good operating condition. MonoDrives provide all the same features as SubDrives, except maximum pump speed is held to 60 Hz for compatibility with the existing pump and motor. While MonoDrives are preset to run the most popular system sizes (3/4 hp (0.55 kW) for MonoDrive, 1.5 hp (1.1 kW) for MonoDriveXT), they can be configured to run a variety of horsepower ratings for maximum flexibility. When retrofitting to an existing 3-wire system, MonoDrive installation is as easy as replacing the existing control box and pressure switch with the MonoDrive controller and pressure sensor. If the existing pump, motor and pressure tank are in good working condition, no further changes are needed.

Pump Sizing - SubDrive75

The SubDrive75 is configured at the factory for use with 3/4 hp (0.55 kW) pumps that are mounted to 1.5 hp (1.1 kW) Franklin Electric three-phase motors. In general, the SubDrive75 will enhance the performance of a 3/4 hp (0.55 kW) pump to a similar or better performance than a conventional 1.5 hp (1.1 kW) pump of the same flow rating (pump series).

To select the proper 3/4 hp (0.55 kW) pump, first choose a 1.5 hp (1.1 kW) curve that meets the application's head and flow requirements. Use the 3/4 hp (0.55 kW) pump in the same pump series (flow rating). The SubDrive75 will adjust the speed of this pump to produce the performance of the 1.5 hp (1.1 kW) curve. An EXAMPLE of this is illustrated in the graph at right. Please consult the pump manufacturer's pump curve for your specific application.

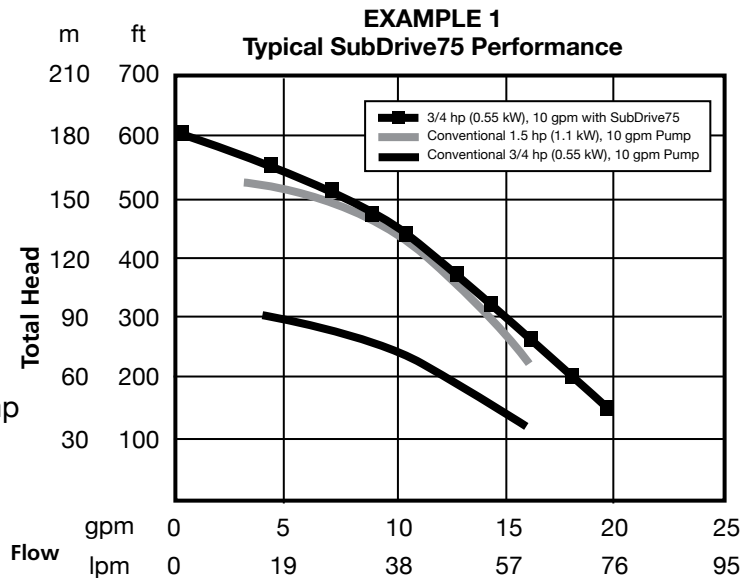

Drive Configuration

The SubDrive75 can also be set up to run a 1.0 hp (0.75 kW) or 1.5 hp (1.1 kW) pump if desired, but larger pumps will still produce to the 1.5 hp (1.1 kW) curve and may only be operated with a 1.5 hp (1.1 kW) motor. To operate a different pump size, a DIP switch must be positioned to select the correct pump rating. Otherwise, the SubDrive75 may trigger erroneous faults.

To configure the SubDrive75 for a 1.0 hp (0.75 kW) or 1.5 hp (1.1 kW) pump, locate the DIP switch marked "SW1". Use a small screwdriver (provided) to change the DIP switch setting according to the chart as shown.

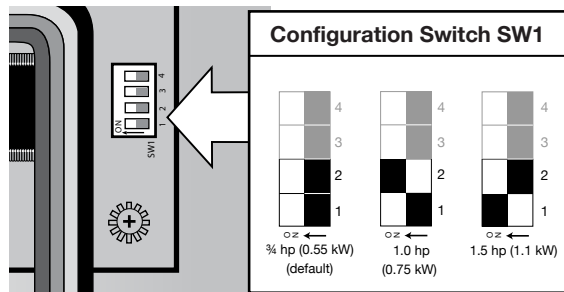

NEMA 1

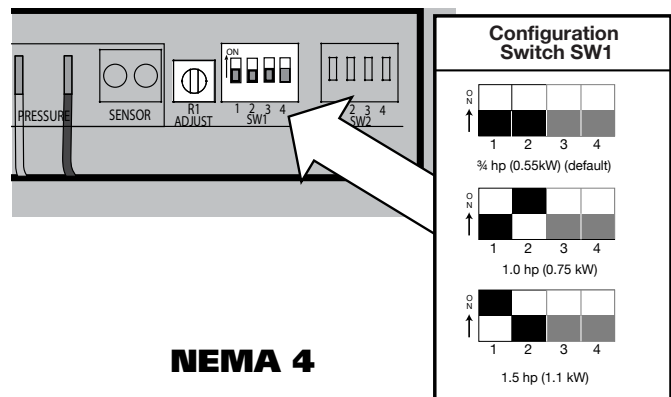

NEMA 4

⚠ WARNING

Serious or fatal electrical shock may result from contact with internal electrical components. DO NOT, under any circumstances, attempt to modify DIP switch settings until power has been removed and 5 minutes have passed for internal voltages to discharge! Power must be removed for DIP switch setting to take effect.

SubDrive/MonoDrive

Pump Sizing – SubDrive100

The SubDrive100 is configured at the factory for use with 1.0 hp (0.75 kW) pumps that are mounted to 2.0 hp (1.5 kW) Franklin Electric three-phase motors. In general, the SubDrive100 will enhance the performance of a 1.0 hp (0.75 kW) pump to a similar or better performance than a conventional 2.0 hp (1.5 kW) pump of the same flow rating (pump series).

To select the proper 1.0 hp (0.75 kW) pump, first choose a 2.0 hp (1.5 kW) curve that meets the application’s head and flow requirements. Use the 1.0 hp (0.75 kW) pump in the same pump series (flow rating). The SubDrive100 will adjust the speed of this pump to produce the performance of the 2.0 hp (1.5 kW) curve. An EXAMPLE of this is illustrated in the graph at right. Please consult the pump manufacturer’s pump curve for your specific application.

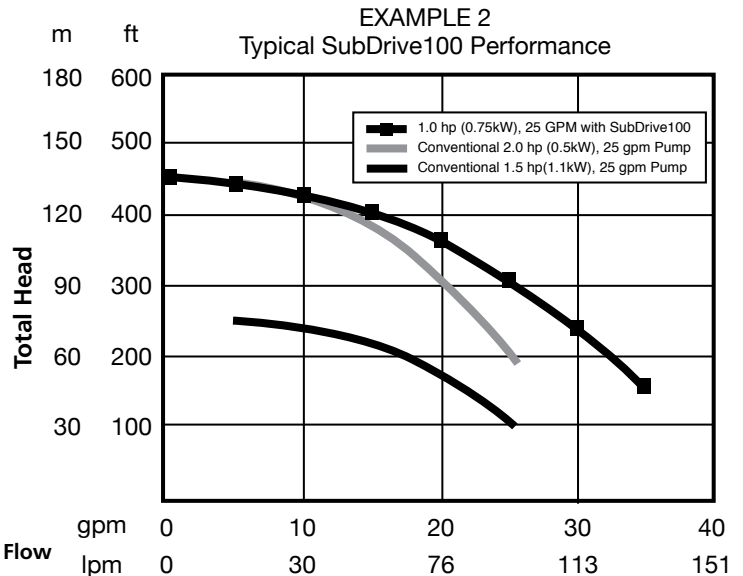

Drive Configuration

The SubDrive100 can also be set up to run a 1.5 hp (1.1 kW) or 2.0 hp (1.5 kW) pump if desired, but larger pumps will still produce to the 2.0 hp (1.5 kW) curve and may only be operated with a 2.0 hp (1.5 kW) motor. To operate a different pump size, a DIP switch must be positioned to select the correct pump rating. Otherwise, the SubDrive100 may trigger erroneous faults.

To configure the SubDrive100 for a 1.5 hp (1.1 kW) or 2.0 hp (1.5 kW) pump, locate the DIP switch marked “SW1”. Use a small screwdriver (provided) to change the DIP switch setting according to the chart as shown.

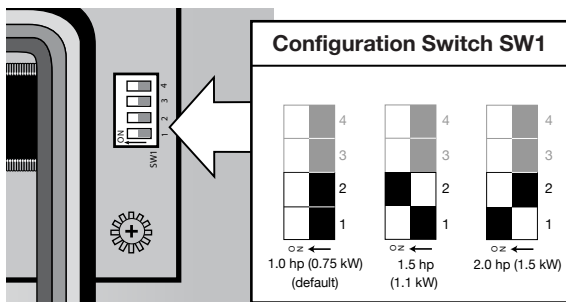

NEMA 1

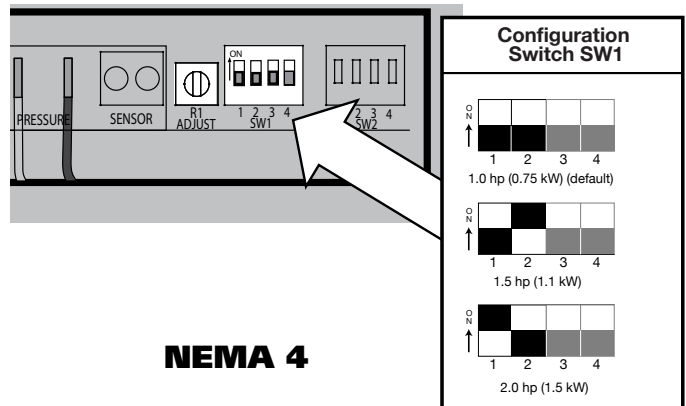

NEMA 4

⚠ WARNING

Serious or fatal electrical shock may result from contact with internal electrical components. DO NOT, under any circumstances, attempt to modify DIP switch settings until power has been removed and 5 minutes have passed for internal voltages to discharge! Power must be removed for DIP switch setting to take effect.

Pump Sizing - SubDrive150

The SubDrive150 is configured at the factory for use with 1.5 hp (1.1 kW) pumps that are mounted to 3.0 hp (2.2 kW) Franklin Electric three-phase motors. In general, the SubDrive150 will enhance the performance of a 1.5 hp (1.1 kW) pump to a similar or better performance than a conventional 3.0 hp (2.2 kW) pump of the same flow rating (pump series).

To select the proper 1.5 hp (1.1 kW) pump, first choose a 3.0 hp (2.2 kW) curve that meets the application's head and flow requirements. Use the 1.5 hp (1.1 kW) pump in the same pump series (flow rating). The SubDrive150 will adjust the speed of this pump to produce the performance of the 3.0 hp (2.2 kW) curve. An EXAMPLE of this is illustrated in the graph at right. Please consult the pump manufacturer's pump curve for your specific application.

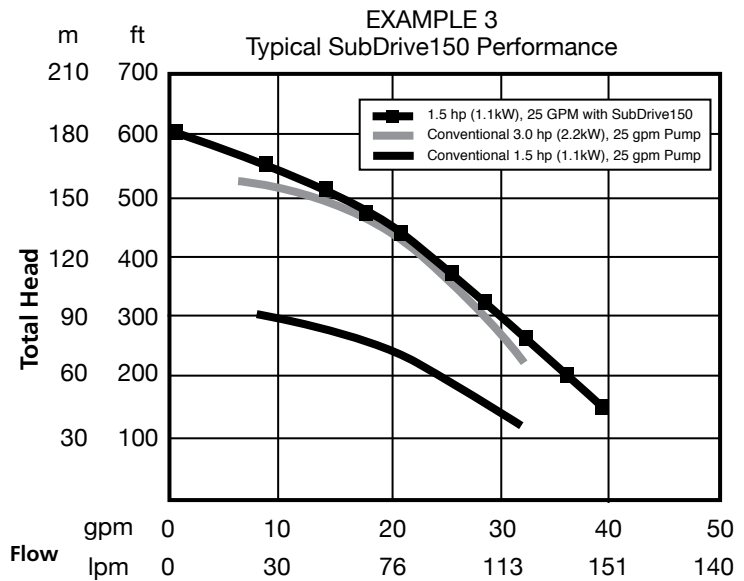

Drive Configuration

The SubDrive150 can also be set up to run a 2.0 hp (1.5 kW) or 3.0 hp (2.2 kW) pump if desired, but larger pumps will still produce to the 3.0 hp (2.2 kW) curve and may only be operated with a 3.0 hp (2.2 kW) motor. To operate a different pump size, a DIP switch must be positioned to select the correct pump rating. Otherwise, the SubDrive150 may trigger erroneous faults.

To configure the SubDrive150 for a 2.0 hp (1.5 kW) or 3.0 hp (2.2 kW) pump, locate the DIP switch marked "SW1". Use a small screwdriver (provided) to change the DIP switch setting according to the chart as shown.

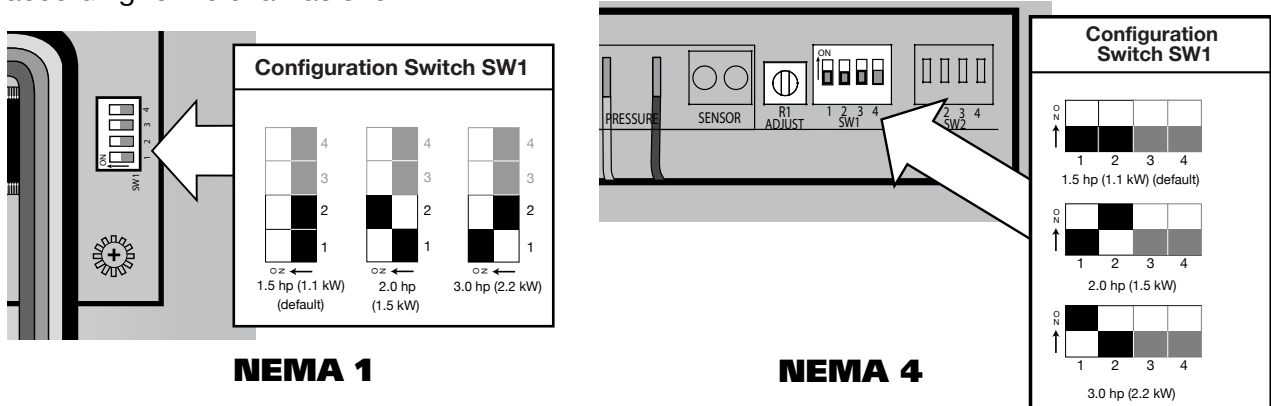

⚠ WARNING

Serious or fatal electrical shock may result from contact with internal electrical components. DO NOT, under any circumstances, attempt to modify DIP switch settings until power has been removed and 5 minutes have passed for internal voltages to discharge! Power must be removed for DIP switch setting to take effect.

SubDrive/MonoDrive

Pump Sizing – SubDrive300

The SubDrive300 is configured at the factory for use with 3.0 hp (2.2 kW) pumps that are mounted to 5.0 hp (3.7 kW) Franklin Electric three-phase motors. In general, the SubDrive300 will enhance the performance of a 3.0 hp (2.2 kW) pump to a similar or better performance than a conventional 5.0 hp (3.7 kW) pump of the same flow rating (pump series).

To select the proper 3.0 hp (2.2 kW) pump, first choose a 5.0 hp (3.7 kW) curve that meets the application’s head and flow requirements. Use the 3.0 hp (2.2 kW) pump in the same pump series (flow rating). The SubDrive300 will adjust the speed of this pump to produce the performance of the 5 hp curve. An EXAMPLE of this is illustrated in the graph at right. Please consult the pump manufacturer’s pump curve for your specific application.

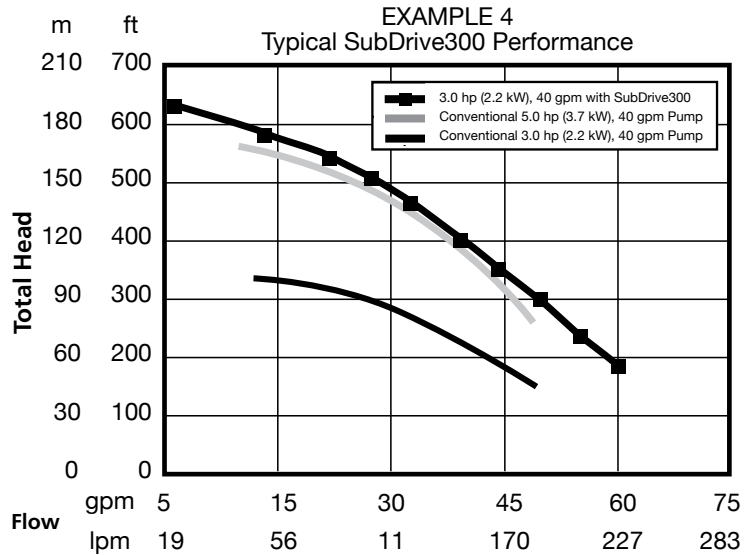

Drive Configuration

The SubDrive300 can also be set up to run a 5.0 hp (3.7 kW) pump if desired, but the larger pump will still produce to the 5.0 hp (3.7 kW) curve and may only be operated with a 5.0 hp (3.7 kW) motor. To operate a different pump size, a DIP switch must be positioned to select the correct pump rating. Otherwise, the SubDrive300 may trigger erroneous faults.

To configure the SubDrive300 for a 5.0 hp (3.7 kW) pump, locate the DIP switch marked “SW1” at the lower right corner of the main circuit board. Use a small screwdriver (provided) to change the DIP switch setting according to the chart as shown.

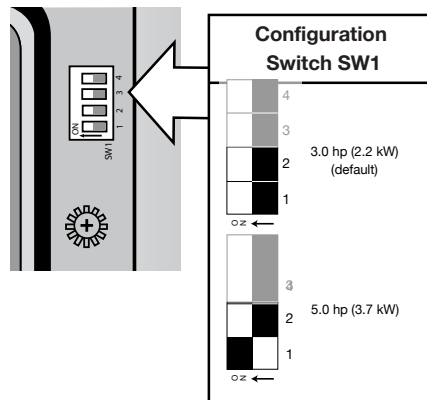

NEMA 4

⚠ WARNING

Serious or fatal electrical shock may result from contact with internal electrical components. DO NOT, under any circumstances, attempt to modify DIP switch settings until power has been removed and 5 minutes have passed for internal voltages to discharge! Power must be removed for DIP switch setting to take effect.

Pump Sizing – SubDrive2W

The SubDrive2W is designed to convert a conventional 1/2 hp (0.37 kW), 3/4 hp (0.55 kW) or 1.0 hp (0.75 kW) pump system to a variable speed constant pressure system by simply replacing the pressure switch. Maximum pump output using the SubDrive2W is similar to the performance achieved using a pressure switch. Therefore, the pump selection criteria are the same as if a pressure switch were used. (Refer to the pump manufacturer’s literature for details of the pump selection procedure.)

If a pump and motor as described above are already installed in the system and the well system components are in good working order, no further system upgrades are required. However, if the existing pump and motor have not been properly chosen, or if the components of the well system are not in good working order, the SubDrive2W cannot be used to correct the problem or extend the life of aging components.

Drive Configuration

By default, the SubDrive2W is configured at the factory to run a 3/4 hp (0.55 kW) system. To operate a 1/2 hp (0.37 kW) or 1.0 hp (0.75 kW) system, a DIP switch must be re-configured to select the proper system rating. Failure to match the configuration to the rating of the pump and motor may trigger erroneous faults.

To configure the SubDrive2W for a 1/2 hp (0.37 kW) or 1.0 hp (0.75 kW) system, locate the DIP switch marked “SW1” at the bottom of the main circuit board. Use a small screwdriver (provided) to change the DIP switch setting according to the chart as shown.

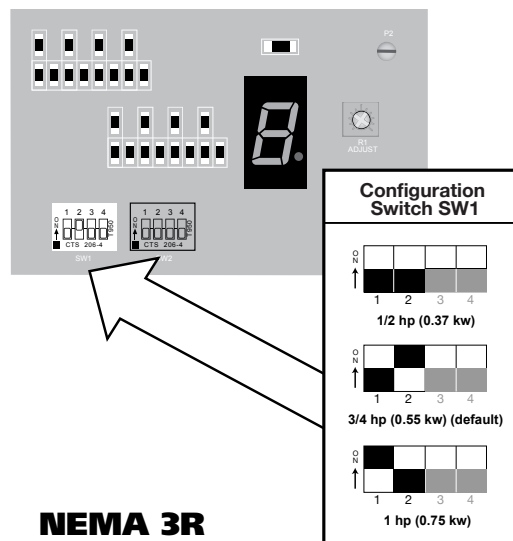

⚠ WARNING

Serious or fatal electrical shock may result from contact with internal electrical components. DO NOT, under any circumstances, attempt to modify DIP switch settings until power has been removed and 5 minutes have passed for internal voltages to discharge! Power must be removed for DIP switch setting to take effect.

SubDrive/MonoDrive

Pump Sizing – MonoDrive

The MonoDrive is designed to convert a conventional 1/2 hp (0.37 kW), 3/4 hp (0.55 kW) or 1.0 hp (0.75 kW) pump system to a variable speed constant pressure system by simply replacing the 3-wire control box and pressure switch. Maximum pump output using the MonoDrive is similar to the performance achieved using a conventional control box. Therefore, the pump selection criteria are the same as if a control box were used. (Refer to the pump manufacturer’s literature for details of the pump selection procedure.)

If a pump and motor as described above are already installed in the system and the well system components are in good working order, no further system upgrades are required. However, if the existing pump and motor have not been properly chosen, or if the components of the well system are not in good working order, the MonoDrive cannot be used to correct the problem or extend the life of aging components.

Drive Configuration

By default, the MonoDrive is configured at the factory to run a 3/4 hp (0.55 kW) system. To operate a 1/2 hp (0.37 kW) or 1.0 hp (0.75 kW) system, a DIP switch must be re-configured to select the proper system rating. Failure to match the configuration to the rating of the pump and motor may trigger erroneous faults.

To configure the MonoDrive for a 1/2 hp (0.37 kW) or 1.0 hp (0.75 kW) system, locate the DIP switch marked “SW1” at the bottom of the main circuit board. Use a small screwdriver (provided) to change the DIP switch setting according to the chart as shown.

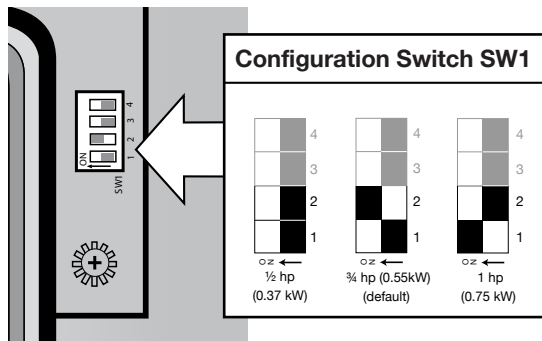

NEMA 1

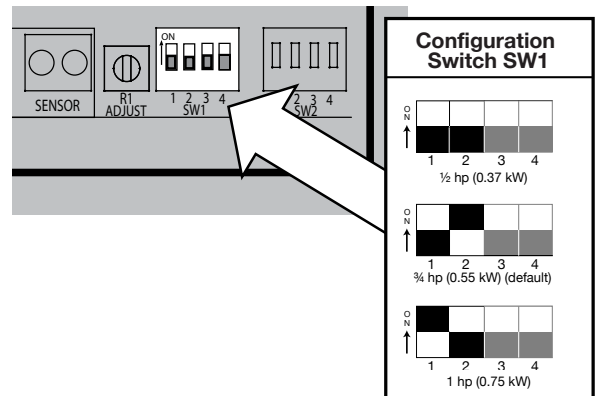

NEMA 4

⚠ WARNING

Serious or fatal electrical shock may result from contact with internal electrical components. DO NOT, under any circumstances, attempt to modify DIP switch settings until power has been removed and 5 minutes have passed for internal voltages to discharge! Power must be removed for DIP switch setting to take effect.

Pump Sizing – MonoDriveXT

The MonoDriveXT is designed to convert a conventional 1.5 hp (1.1 kW) or 2.0 hp (1.5 kW) pump system to a variable speed constant pressure system by simply replacing the 3-wire control box and pressure switch. Maximum pump output using the MonoDriveXT is similar to the performance achieved using a conventional control box. Therefore, the pump selection criteria are the same as if a control box were used. Please refer to the pump manufacturer’s literature for details of the pump selection procedure.

If a pump and motor as described above are already installed in the system and the well system components are in good working order, no further system upgrades are required. However, if the existing pump and motor have not been properly chosen, or if the components of the well system are not in good working order, the MonoDriveXT cannot be used to correct the problem or extend the life of aging components.

Drive Configuration

By default, the MonoDriveXT is configured at the factory to run a 1.5 hp (1.1 kW) system. To operate a 2.0 hp (1.5 kW) system, a DIP switch must be reconfigured to select the proper system rating. Failure to match the configuration to the rating of the pump and motor may trigger erroneous faults.

To configure the MonoDriveXT for a 2.0 hp (1.5 kW) system, locate the DIP switch marked “SW1” at the bottom of the main circuit board. Use a small screwdriver (provided) to change the DIP switch setting according to the chart as shown.

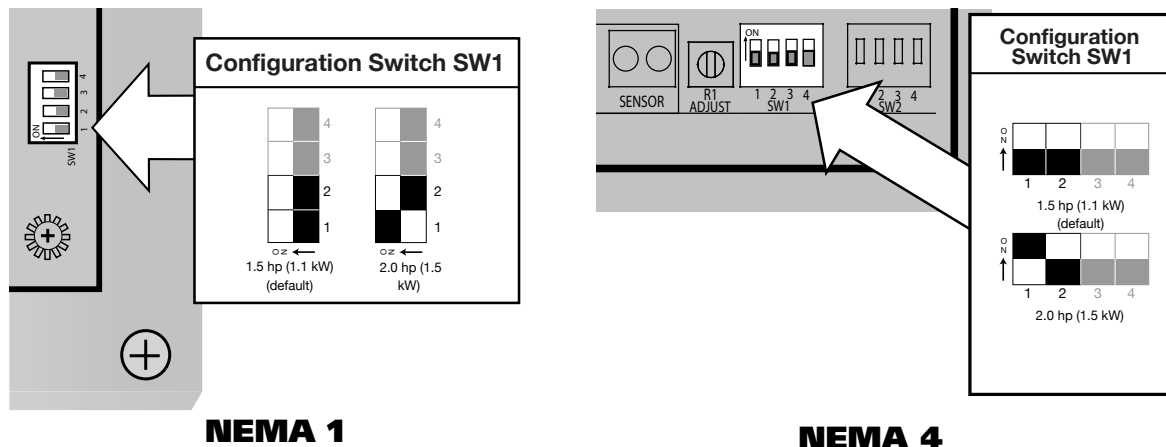

⚠ WARNING
 Serious or fatal electrical shock may result from contact with internal electrical components. DO NOT, under any circumstances, attempt to modify DIP switch settings until power has been removed and 5 minutes have passed for internal voltages to discharge! Power must be removed for DIP switch setting to take effect.

SubDrive/MonoDrive

Underload Sensitivity Selection (NEMA 1) – SubDrive75/100/150, MonoDrive, MonoDriveXT

The SubDrive/MonoDrive controller is configured at the factory to ensure detection of Underload faults in a wide variety of pumping applications. In rare cases (as with certain pumps in shallow wells) this trip level may result in nuisance faults. If the pump is installed in a shallow well, activate the controller and observe system behavior. Once the controller begins to regulate pressure, check operation at several flow rates to make sure the default sensitivity does not induce nuisance Underload trips.

If it becomes necessary to desensitize the Underload trip level, remove power and allow the controller to discharge. Once the internal voltages have dissipated, locate the DIP switch marked “SW1” at the lower right corner of the main circuit board. Use a small screwdriver (provided) to change Position 3 to the “ON” position to select the lower Underload sensitivity as shown in the chart below.

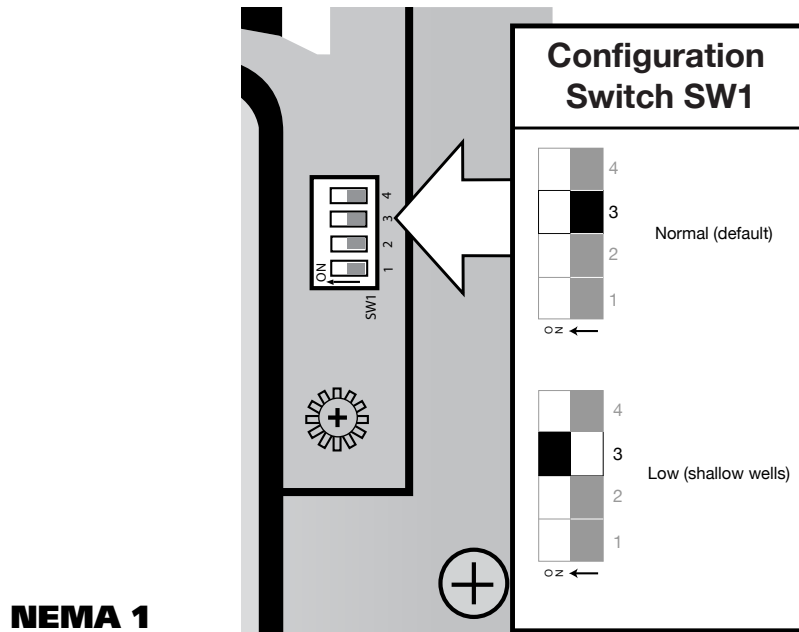

⚠ WARNING

Serious or fatal electrical shock may result from contact with internal electrical components. DO NOT, under any circumstances, attempt to modify DIP switch settings until power has been removed and 5 minutes have passed for internal voltages to discharge! Power must be removed for DIP switch setting to take effect.

Underload Sensitivity Selection NEMA 4 and NEMA 3R

The SubDrive/MonoDrive controller is configured at the factory to ensure detection of Underload faults in a wide variety of pumping applications. In rare cases (as with certain pumps in shallow wells) this trip level may result in nuisance faults. If the pump is installed in a shallow well, activate the controller and observe system behavior. Once the controller begins to regulate pressure, check operation at several flow rates to make sure the default sensitivity does not induce nuisance Underload trips.

If it becomes necessary to desensitize the Underload trip level, remove power and allow the controller to discharge. Once the internal voltages have dissipated, locate the DIP switch marked “SW1” to the right of the sensor connection. Use a small screwdriver (provided) to change Position 3 to the “ON” position to select the lower Underload sensitivity as shown in the charts below.

If the pump is installed in an extremely shallow (i.e. artesian) well and the system continues to trip even with Position 3 of the DIP switch set to the ON position for “Low (shallow wells)”, then the Underload Potentiometer (Pot) will need to be adjusted to a lower sensitivity setting. Using a non-conductive (i.e. plastic) pot adjustment tool, adjust the pot located just to the right of the sensor connection counterclockwise. Check the Underload trip level and repeat as necessary.

In cases where the pump is set very deep, run the system at open discharge to pump the well down and observe carefully that an Underload is detected properly. If the system does not trip as it should, then the Underload Pot will need to be adjusted clockwise to a higher sensitivity setting.

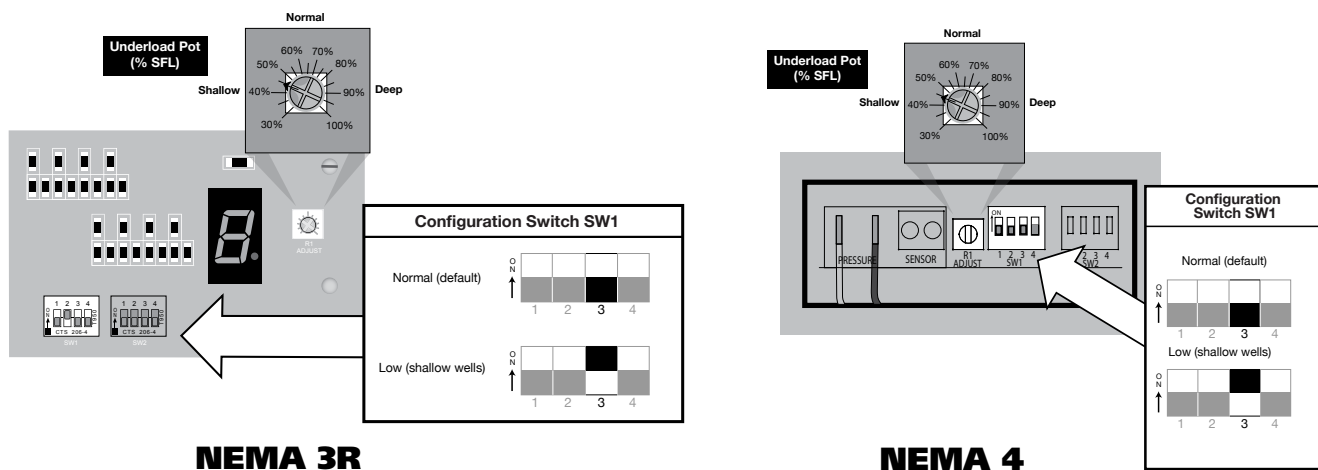

⚠ WARNING

Serious or fatal electrical shock may result from contact with internal electrical components. DO NOT, under any circumstances, attempt to modify DIP switch settings until power has been removed and 5 minutes have passed for internal voltages to discharge! Power must be removed for DIP switch setting to take effect.

SubDrive/MonoDrive

Underload Sensitivity Selection SubDrive300

The SubDrive300 controller is configured at the factory to ensure detection of Underload faults in a wide variety of pumping applications. In rare cases (as with certain pumps in shallow wells) this trip level may result in nuisance faults. If the pump is installed in a shallow well, activate the controller and observe system behavior. Once the controller begins to regulate pressure, check operation at several flow rates to make sure the default sensitivity does not induce nuisance Underload trips.

If it becomes necessary to desensitize the Underload trip level, remove power and allow the controller to discharge. Once the internal voltages have dissipated, locate the DIP switch marked “SW1” to the right of the sensor connection. Use a small screwdriver (provided) to change Position 3 to the “ON” position to select the lower Underload sensitivity as shown in the charts below.

If the pump is installed in an extremely shallow (i.e. artesian) well and the system continues to trip even with Position 3 of the DIP switch set to the ON position for “Low (shallow wells)”, then the Underload Potentiometer (Pot) will need to be adjusted to a lower sensitivity setting. Using a non-conductive (i.e. plastic) pot adjustment tool, adjust the pot located just to the right of the sensor connection counterclockwise. Check the Underload trip level and repeat as necessary.

In cases where the pump is set very deep, run the system at open discharge to pump the well down and observe carefully that an Underload is detected properly. If the system does not trip as it should, then the Underload Pot will need to be adjusted clockwise to a higher sensitivity setting.

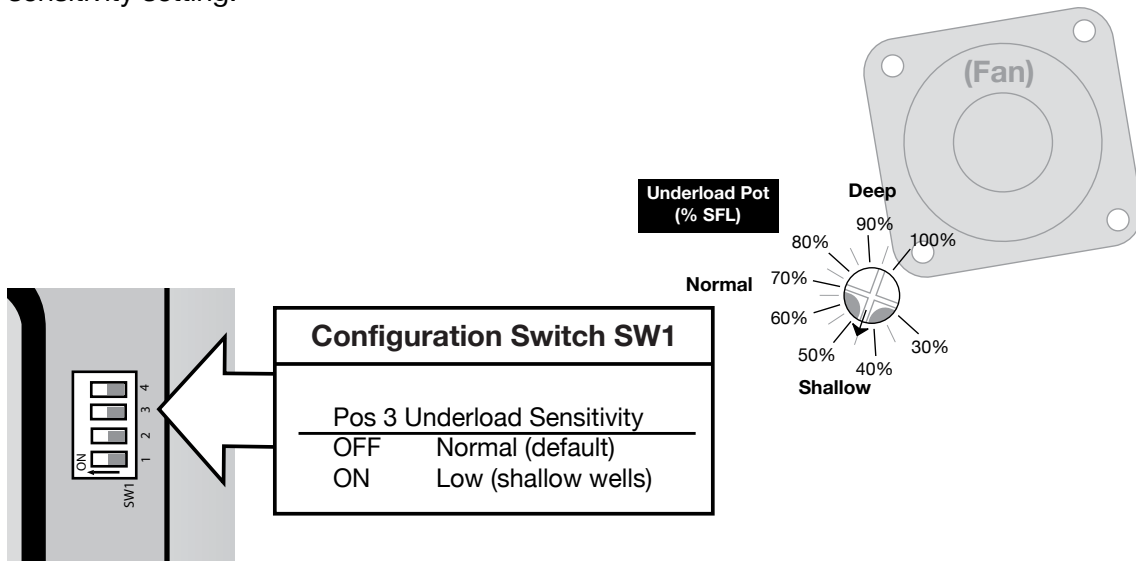

⚠ WARNING

Serious or fatal electrical shock may result from contact with internal electrical components. DO NOT, under any circumstances, attempt to modify DIP switch settings until power has been removed and 5 minutes have passed for internal voltages to discharge! Power must be removed for DIP switch setting to take effect.

Steady Flow Selection

SubDrive75/100/150/300, SubDrive2W/MonoDrive/MonoDriveXT

The SubDrive/MonoDrive controller is configured at the factory to ensure quick response to maintain constant pressure. In rare cases (as with a water line tap before the pressure tank), the controller may need to be adjusted to offer better control.

If the controller is used on a system that has a water line tapped before the pressure tank and close to the well head or where audible speed variations of the PMA can be heard through the pipes, adjusting the pressure control response time may be necessary. After enabling this feature, the installer should check flow changes for possible overshoot. A larger pressure tank and/or wider margin between regulation and valve pressure may be required as the Steady Flow features reduce the controller’s reaction time to sudden changes in flow.

If it is necessary to adjust the pressure control, remove power and allow the controller to discharge. Wait 5 minutes to allow internal voltage to dissipate, locate the DIP switch marked “SW1”. Use a small screwdriver (provided) to move position 4 to “ON” as shown.

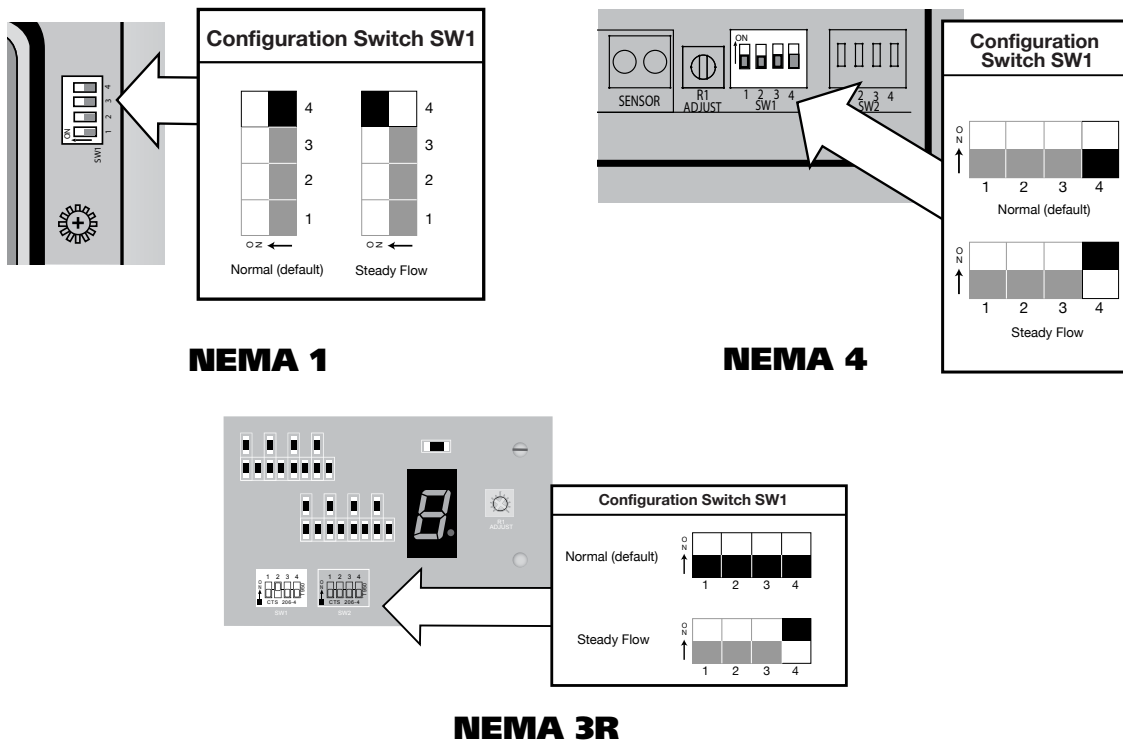

⚠ WARNING
 Serious or fatal electrical shock may result from contact with internal electrical components. DO NOT, under any circumstances, attempt to modify DIP switch settings until power has been removed and 5 minutes have passed for internal voltages to discharge! Power must be removed for DIP switch setting to take effect.

SubDrive/MonoDrive

Sleep Mode

The SubDrive2W has been configured with a Sleep mode to disable the unit in the event the end-user requires it. The Sleep mode can be enabled by pressing the Sleep mode button found on the bottom of the unit for five (5) seconds. The Status indicator will display 3 horizontal segments. In Sleep mode, power is still applied to the drive; however, the unit will not operate the water system until Sleep mode is disengaged. To disengage Sleep mode, depress the Sleep mode button found on the bottom of the unit for five (5) seconds.

Underload Smart Reset

If a motor Underload fault condition occurs, the most likely cause is an overpumped or dry well. To allow the well to recover, the SubDrive/MonoDrive controller will wait 30 seconds to 5 minutes, determined by duration of the previous run time, before restarting the motor. For example, the first time the fault occurs, the controller will wait 30 seconds before attempting to restart the pump. If the system would then run for 1 minute and an Underload fault recurs, the controller will wait 4 minutes before attempting to restart the pump. This schedule allows for the minimum off-time possible based on the recovery time of the well.

Figure 1: Smart Reset Well Recovery Time

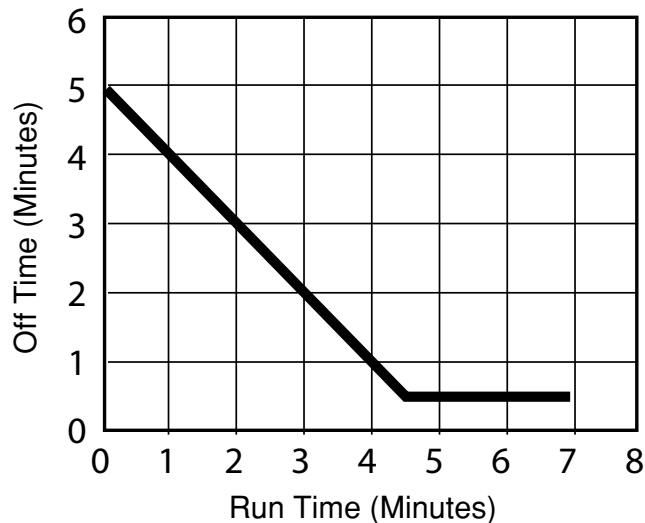

Over Temperature Foldback

The SubDrive/MonoDrive controller is designed for full power operation in ambient temperatures up to 125° F (50° C) as long as the input voltage is kept at 230 VAC. Under extreme thermal conditions, the controller will reduce output power in an attempt to avoid shutdown. Full pump output is restored when the controller temperature cools to a safe level.

System Run Relay – SubDrive300/SubDrive2W

The SubDrive300/SubDrive2W is fitted with a relay output that activates (normally-open contact will close) whenever the system is actively pumping. This relay may be used to control other water system equipment such as water treatment systems that need to operate only when water is being used. Both normally-open (NO) and normally-closed (NC) contacts are provided. The contacts are rated 5 A at 250 VAC/30 VDC for general purpose loads, or 2 A at 250 VAC/30VDC for inductive loads (i.e. relay).

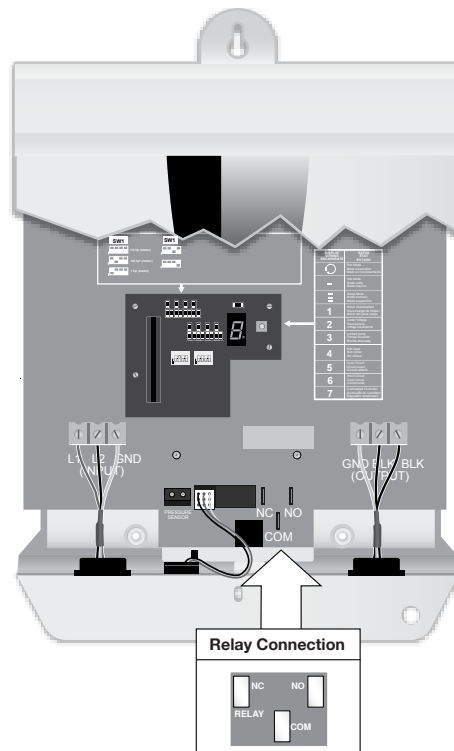
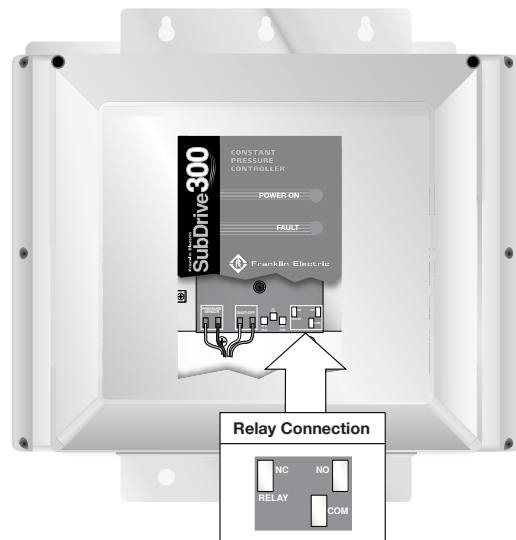

SubDrive/MonoDrive

Generator Sizing for SubDrive/MonoDrive

Basic generator sizing for the Franklin Electric SubDrive/MonoDrive system is 1.5 times maximum input Watts consumed by the drive, rounded up to the next normal sized generator.

Recommended minimum generator sizes:

MonoDrive

1/2 hp (0.37 kW) = 2000 Watts (2 kW)

3/4 hp (0.55 kW) = 3000 Watts (3 kW)

1 hp (0.75 kW) = 3500 Watts (3.5 kW)

MonoDriveXT

1.5 hp (1.1kW) = 4000 Watts (4 kW)

2 hp (1.5 kW) = 5000 Watts (5 kW)

SubDrive75 = 3500 Watts (3.5 kW)

SubDrive100 = 5700 Watts (6 kW)

SubDrive150 = 7000 Watts (7 kW)

SubDrive300 = 11000 Watts (11 kW)

SubDrive2W = 6000 Watts (6 kW)

NOTE: Not to be used on a Ground Fault Circuit Interruptor (GFCI). If using an externally regulated generator, verify that the voltage, hertz, and idle speed are appropriate to supply the drive.

Controller Location Selection

The SubDrive controller is intended for operation in ambient temperatures up to 125° F (50° C) at 230 VAC input. The following recommendations will help in selection of the proper location of the SubDrive unit:

1. A tank tee is recommended for mounting the tank, pressure sensor, pressure gauge, and pressure relief valve at one junction. If a tank tee is not used, the pressure sensor should be located within 6 feet (1.8 meters) of the pressure tank to minimize pressure fluctuations. There should be no elbows between the tank and pressure sensor.
2. The unit should be mounted on a sturdy supporting structure such as a wall or supporting post. Please take into account the weight of the unit.
3. The electronics inside the SubDrive/MonoDrive are air-cooled. As a result, there should be at least 6 inches (15.24 cm) of clearance on each side and below the unit to allow room for air flow.
4. Do not expose a SubDrive/MonoDrive with NEMA 1 enclosure to rain or water spray. For outdoor installations, select a controller with the NEMA 4 enclosure option only. Please see additional considerations for NEMA 4.
5. The SubDrive/MonoDrive should only be mounted with the wiring end oriented downward. The controller should not be placed in direct sunlight or other locations subject to extreme temperatures or humidity (mounting location should not be subjected to freezing conditions or condensation).
6. The mounting location should have access to 230 VAC electrical supply and to the submersible motor wiring. To avoid possible interference with other appliances, please refer to the Installation Guide and observe all precautions regarding power cable routing.

⚠ CAUTION
 There should be at least 6 inches of clearance on each side and below the SubDrive/MonoDrive unit to allow room for air flow.

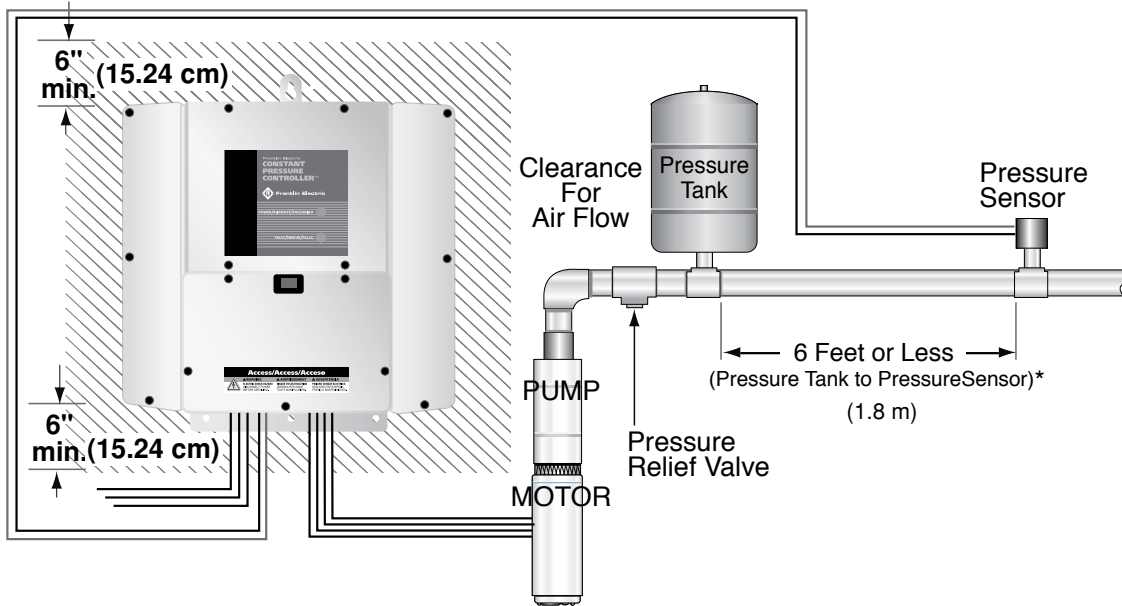

* NOTE: There should be no elbows between the tank and pressure sensor.

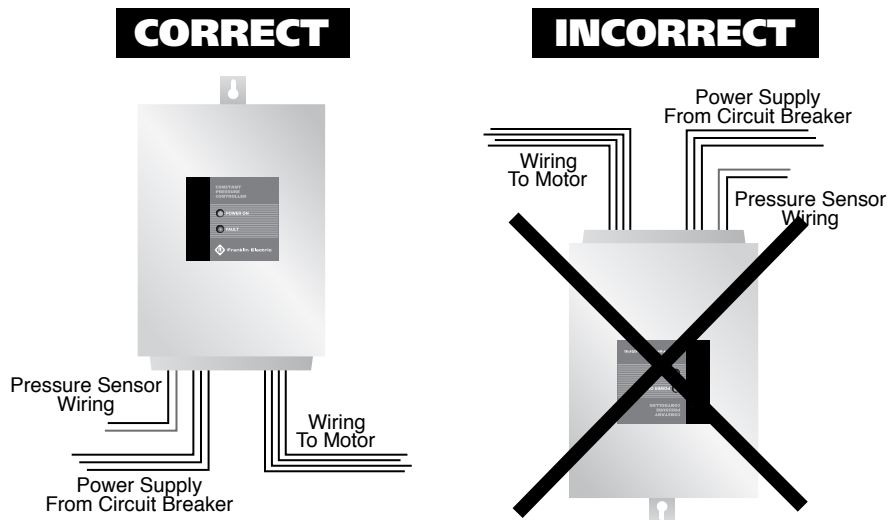

Additional Considerations for NEMA 4 Enclosures

To assure maximum weather protection, the unit must be mounted vertically with the cover properly aligned and secured with all lid screws. Strain relief fittings should be used to close off all gaps around wires.

Quick Reference Guide to Controller Installation NEMA 1 SubDrive75/100/150/MonoDrive/MonoDriveXT

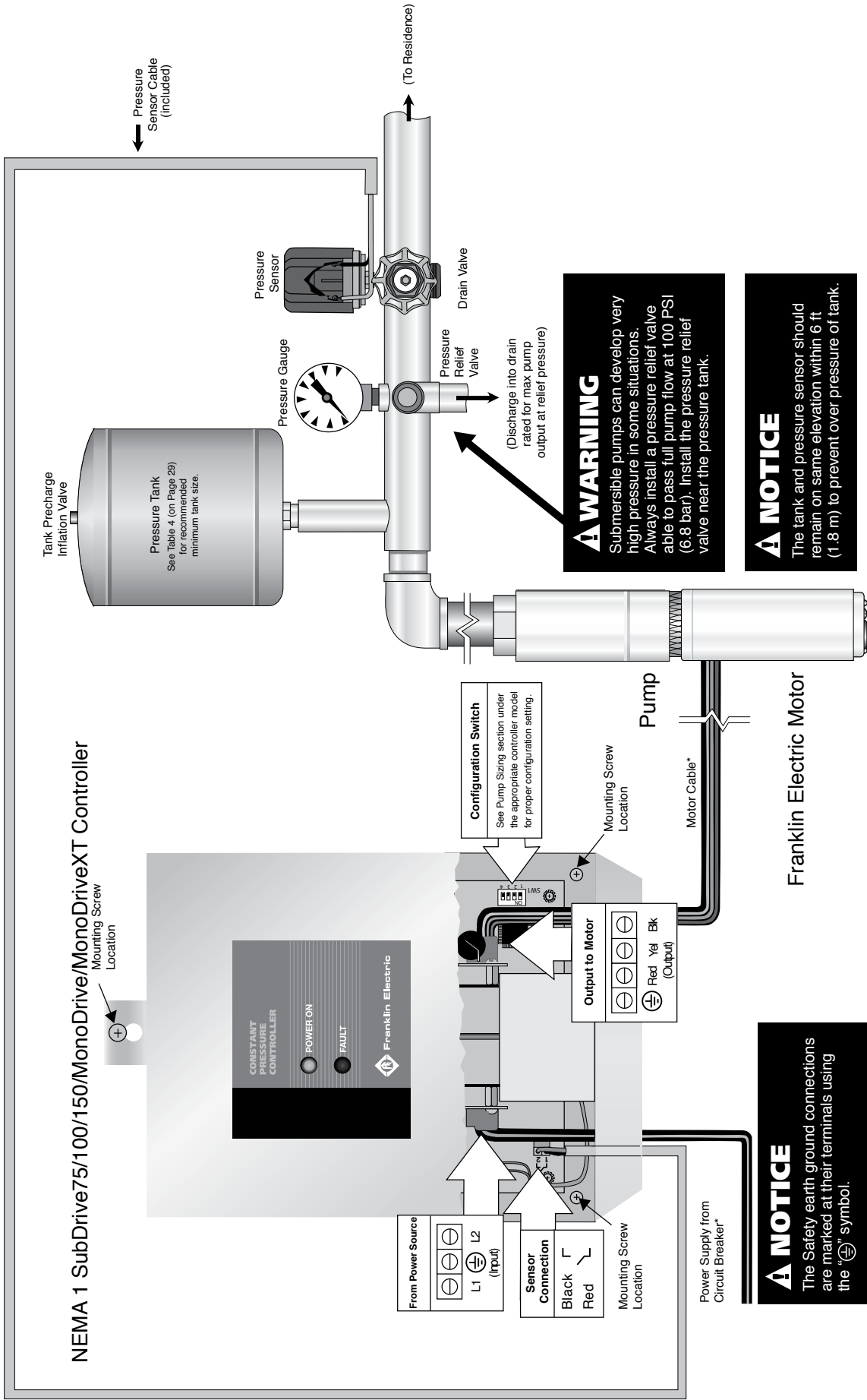

⚠ WARNING
Submersible pumps can develop very high pressure in some situations. Always install a pressure relief valve able to pass full pump flow at 100 PSI (6.8 bar). Install the pressure relief valve near the pressure tank.

⚠ NOTICE
The tank and pressure sensor should remain on same elevation within 6 ft (1.8 m) to prevent over pressure of tank.

⚠ NOTICE
The Safety earth ground connections are marked at their terminals using the "⊕" symbol.

* **Note:** To avoid possible interference with other appliances, please refer to the Installation Guide and observe all precautions regarding power cable routing.

Quick Reference Guide to Controller Installation NEMA 4 SubDrive75/100/150/MonoDrive/MonoDriveXT

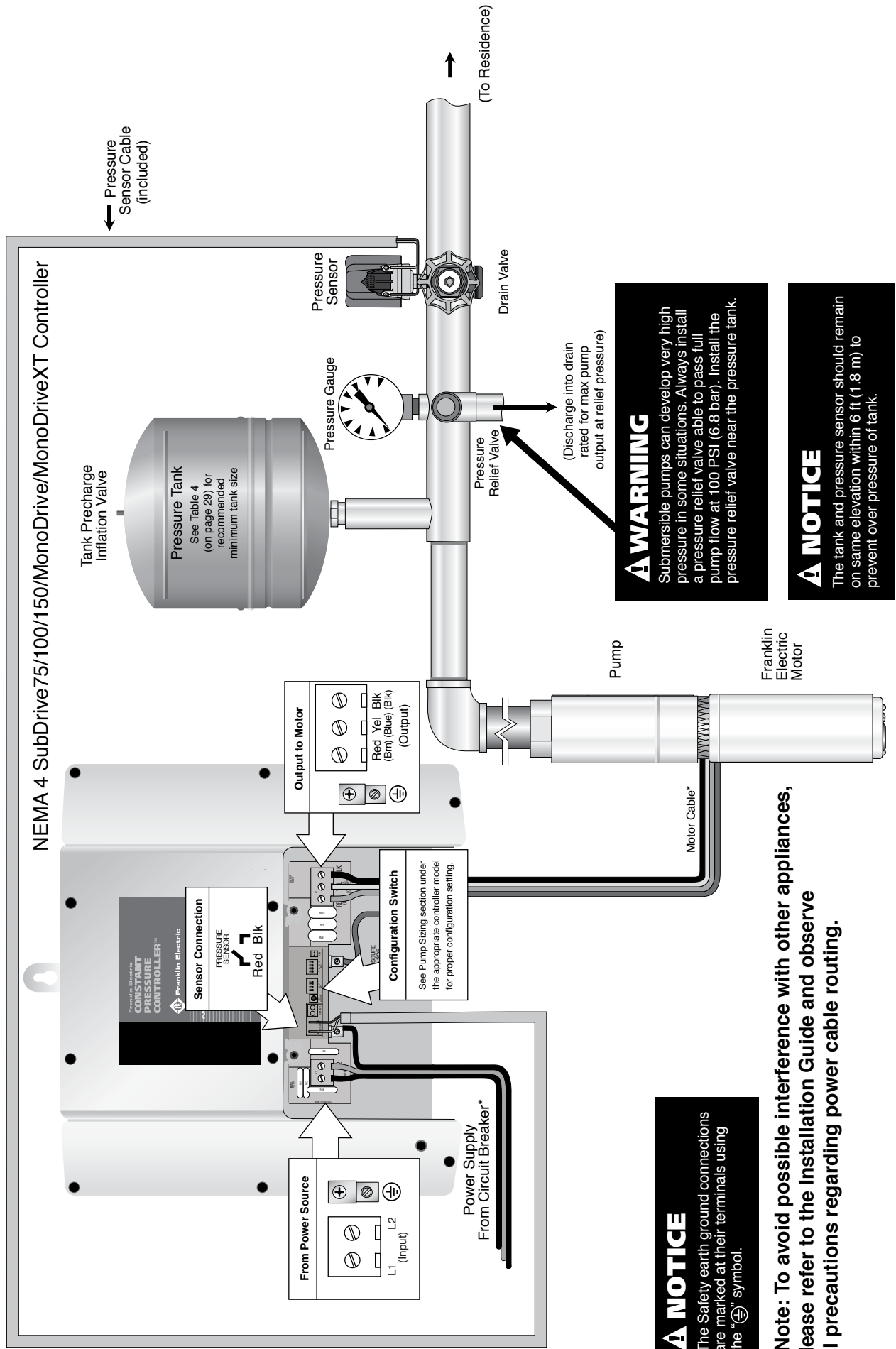

⚠ WARNING
Submersible pumps can develop very high pressure in some situations. Always install a pressure relief valve able to pass full pump flow at 100 PSI (6.8 bar). Install the pressure relief valve near the pressure tank.

⚠ NOTICE
The tank and pressure sensor should remain on same elevation within 6 ft (1.8 m) to prevent over pressure of tank.

⚠ NOTICE
The Safety earth ground connections are marked at their terminals using the ⚡ symbol.

* Note: To avoid possible interference with other appliances, please refer to the Installation Guide and observe all precautions regarding power cable routing.

Quick Reference Guide to Controller Installation NEMA 4 SubDrive300

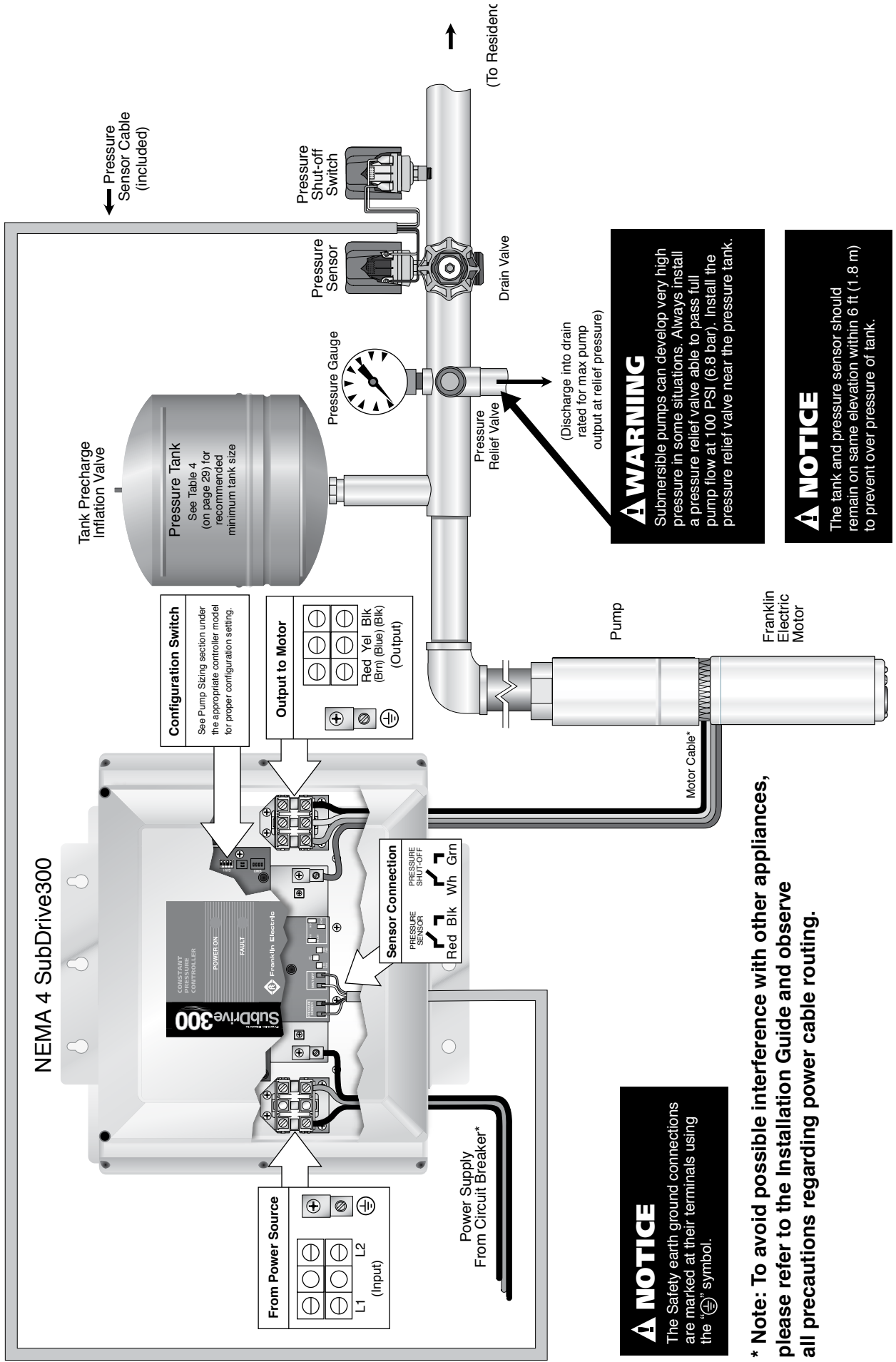

WARNING
Submersible pumps can develop very high pressure in some situations. Always install a pressure relief valve able to pass full pump flow at 100 PSI (6.8 bar). Install the pressure relief valve near the pressure tank.

NOTICE
The tank and pressure sensor should remain on same elevation within 6 ft (1.8 m) to prevent over pressure of tank.

NOTICE
The Safety earth ground connections are marked at their terminals using the "E" symbol.

* Note: To avoid possible interference with other appliances, please refer to the Installation Guide and observe all precautions regarding power cable routing.

Quick Reference Guide to Controller Installation NEMA 3R SubDrive2W

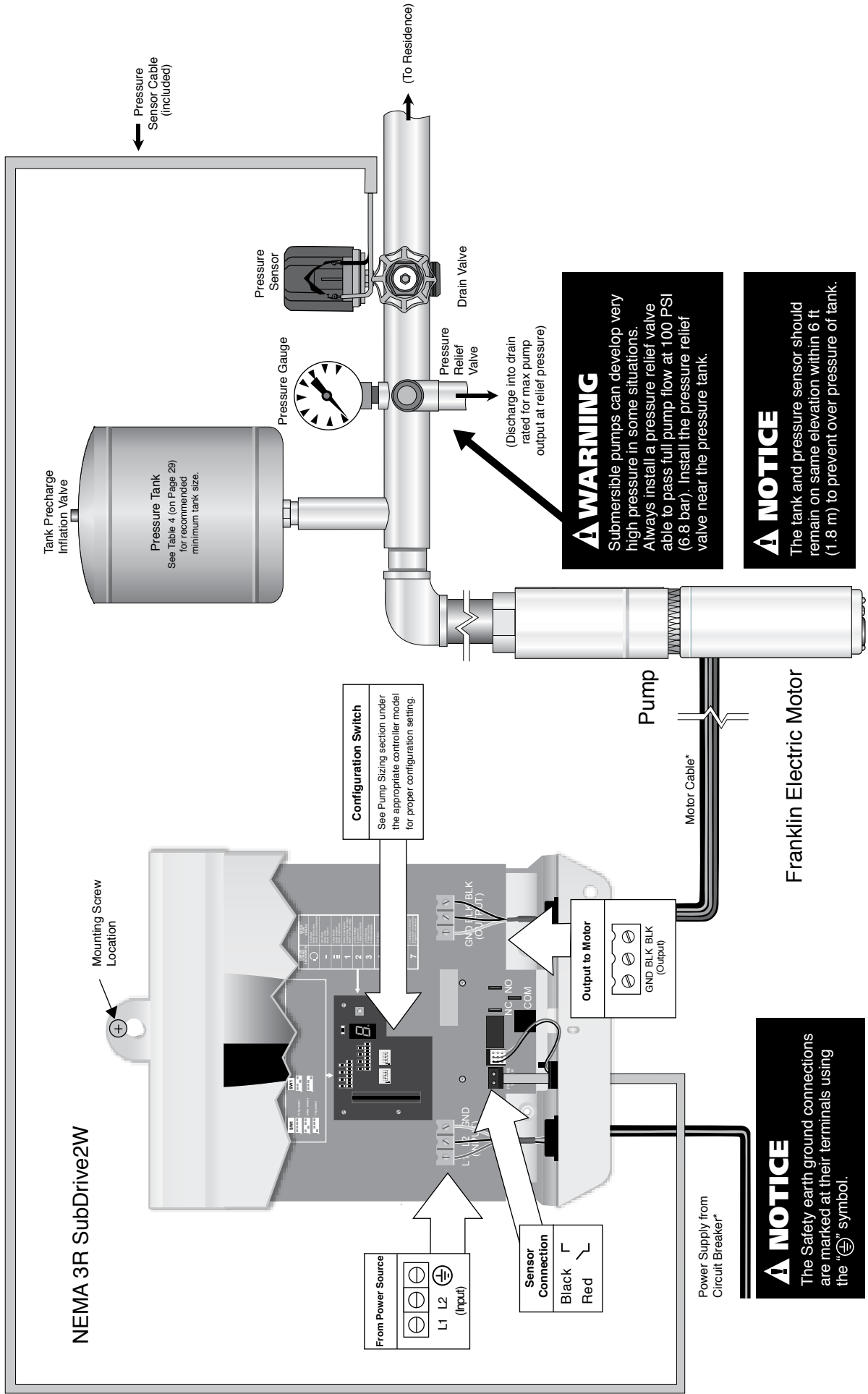

* **Note:** To avoid possible interference with other appliances, please refer to the Installation Guide and observe all precautions regarding power cable routing.

SubDrive/MonoDrive

Fuse/Circuit Breaker and Wire Sizing

The Listed fuse/Listed circuit breaker size and maximum allowable wire lengths for connection to the SubDrive/MonoDrive are given in the following tables:

Table 2: Circuit Breaker Sizing and Maximum Input Cable Lengths (in Feet)
Based on a 3% voltage drop

Model Family	Listed fuse / Listed Circuit Breaker Amps	Nominal Input Voltage	AWG Copper Wire Sizes, 167° F (75° C) Insulation Unless Otherwise Noted										
			14	12	10	8	6	4	3	2	1	1/0	2/0
MonoDrive	15	208	80	125	205	315	500	790	980	1290	1635	-	-
	15	230	95	150	250	385	615	970	1200	1580	2000	-	-
SubDrive75	15	208	70	110	185	280	450	710	880	1160	1465	-	-
	15	230	85	135	225	345	550	865	1075	1415	1795	-	-
SubDrive2W	20	230	-	125	205	315	505	795	985	1295	1645	-	-
MonoDriveXT	20	208	-	85	140	220	345	550	680	895	1135	-	-
	20	230	-	105	175	265	425	670	835	1095	1390	-	-
SubDrive100	25	208	-	-	115	180	285	450	555	730	925	-	-
	20	230	-	85	140	220	345	550	680	895	1130	-	-
SubDrive150	30	208	-	-	95	145	235	370	460	605	765	-	-
	25	230	-	-	115	180	285	455	560	740	935	-	-
SubDrive300	40	208	-	-	-	-	150	235	295	385	490	610	735
	40	230	-	-	-	115	185	290	360	470	600	745	895

XXXX Highlighted Numbers denote wire with 194° F (90° C) insulation only

Table 3: Maximum Motor Cable Length (in feet)

Controller Model	Franklin Electric Motor Model	HP	AWG Copper Wire Sizes, 140° F (60° C) Insulation					
			14	12	10	8	6	4
SubDrive75	234 514 xxxx	1.5 (1.1 kW)	420	670	1060	-	-	-
SubDrive100	234 315 xxxx	2.0 (1.5 kW)	320	510	810	1000	-	-
SubDrive150	234 316 xxxx	3.0 (2.2 kW)	240	390	620	990	-	-
SubDrive300	234 317 xxxx	5.0 (3.7 kW)	-	230	370	590	920	-
SubDrive2W	244 505 xxxx	1/2 (.37 kW)	400	650	1000	-	-	-
	244 507 xxxx	3/4 (.55 kW)	300	480	760	1000	-	-
	244 508 xxxx	1.0 (.75 kW)	250	400	630	990	-	-
MonoDrive	214 505 xxxx	1/2 (.37 kW)	400	650	1020	-	-	-
	214 507 xxxx	3/4 (.55 kW)	300	480	760	1000	-	-
	214 508 xxxx	1.0 (.75 kW)	250	400	630	990	-	-
MonoDriveXT	224 300 xxxx	1.5 (1.1 kW)	190	310	480	770	1000	-
	224 301 xxxx	2.0 (1.5kW)	150	250	390	620	970	-

NOTE: 1 ft = 0.305 m

A 10-foot (3.05 m) section of cable is provided with the SubDrive/MonoDrive to connect the pressure sensor.

NOTE:

- Maximum allowable wire lengths are measured between the controller and motor.
- Aluminum wires should not be used with the SubDrive/MonoDrive.
- All wiring to comply with the National Electrical Code and/or local codes.
- MonoDrive minimum breaker amps may be lower than AIM Manual specifications for the motors listed due to the soft-starting characteristic of the MonoDrive controller.
- SubDrive minimum breaker amps may appear to exceed AIM Manual specifications for the motors listed because SubDrive controllers are supplied from a single-phase service rather than three-phase.
- Motor Overload Protection Note: The drive electronics provide motor overload protection by preventing motor current from exceeding the maximum Service Factor Amps (SFA). Motor overtemperature sensing is not provided by the drive.

Pressure Tank

The SubDrive/MonoDrive needs only a small pressure tank to maintain constant pressure. (See table below for recommended tank size.) For pumps rated 12 gpm (45.4 lpm) or more, a slightly larger tank is recommended for optimum pressure regulation. The SubDrive/MonoDrive can also use an existing tank with a much larger capacity.

Table 4: Minimum Pressure Tank Size (Total Capacity)

Pump Flow Rating	Controller Model	Minimum Tank Size
Less than 12 gpm (45.4 lpm)	SubDrive75 or MonoDrive	2 gallons (7.6 liters)
	SubDrive100	4 gallons (15.1 liters)
	SubDrive150 or MonoDriveXT	4 gallons (15.1 liters)
	SubDrive300	8 gallons (30.3 liters)
12 gpm and higher (45.4 lpm)	SubDrive75 or MonoDrive	4 gallons (15.1 liters)
	SubDrive100	8 gallons (30.3 liters)
	SubDrive150 or MonoDriveXT	8 gallons (30.3 liters)
	SubDrive300	20 gallons (75.7 liters)
All flows	SubDrive2W	20 gallons (75.7 liters)

The minimum supply pipe diameter should be selected not to exceed a maximum velocity of 8 ft/ sec (2.4 m/s) (See Table 6 below for minimum pipe diameter). The pressure tank pre-charge setting should be 70% of the system pressure sensor setting as indicated in the following table.

Table 5: Pressure Tank Pre-charge (PSI)

System Pressure (at Pressure Sensor)	Pressure Tank Setting (±2 psi)
25	18
30	21
35	25
40	28
45	32
50 Factory Setting	35
55	39
60	42
65	46
70	49
75	53
80	56

Table 6: Minimum Pipe Diameter

Maximum Velocity 8 ft/sec. (2.4 m/s)	
Min Pipe Dia	Max GPM (lpm)
1/2"	4.9 (18.5)
3/4"	11.0 (41.6)
1"	19.6 (74.2)
1-1/4"	30.6 (115.8)
1-1/2"	44.1 (166.9)
2"	78.3 (296.4)
2-1/2"	176.3 (667.4)

1 PSI = 0.068 bar

NOTE: Check tank pre-charge regularly to maintain optimum pressure regulation.

SubDrive/MonoDrive

Installation Procedure

1. Disconnect electrical power at the main breaker.
2. Drain the system (if applicable).
3. Install the pressure sensor (NSF 61 rated) at the pressure tank tee downstream of the pressure tank. (The pressure tank should be between the pressure sensor and the pump.) The pressure sensor has a 1/4-18 National Pipe Thread (NPT) connection. The pressure sensor should not be installed in an inverted orientation (upside down). Make sure the pressure sensor and tank are not located more than 3 feet (0.9 m) off the main piping.
4. Install the unit to the wall using 1/4" (2.54 cm) mounting screws (not included) as shown in Figure 1 below. The top mounting holes are slotted in order to hang the drive in place, while the bottom fasteners are inserted to secure the unit from ever sliding up.
5. If the mounting surface is a 4" (10 cm) × 4" (10 cm) wooden post for the NEMA 4 models, use the top center and bottom center mounting holes.
6. Remove the SubDrive lid as shown in Figure 2 below.

Figure 2: Shipping / Mounting / Lid Screws

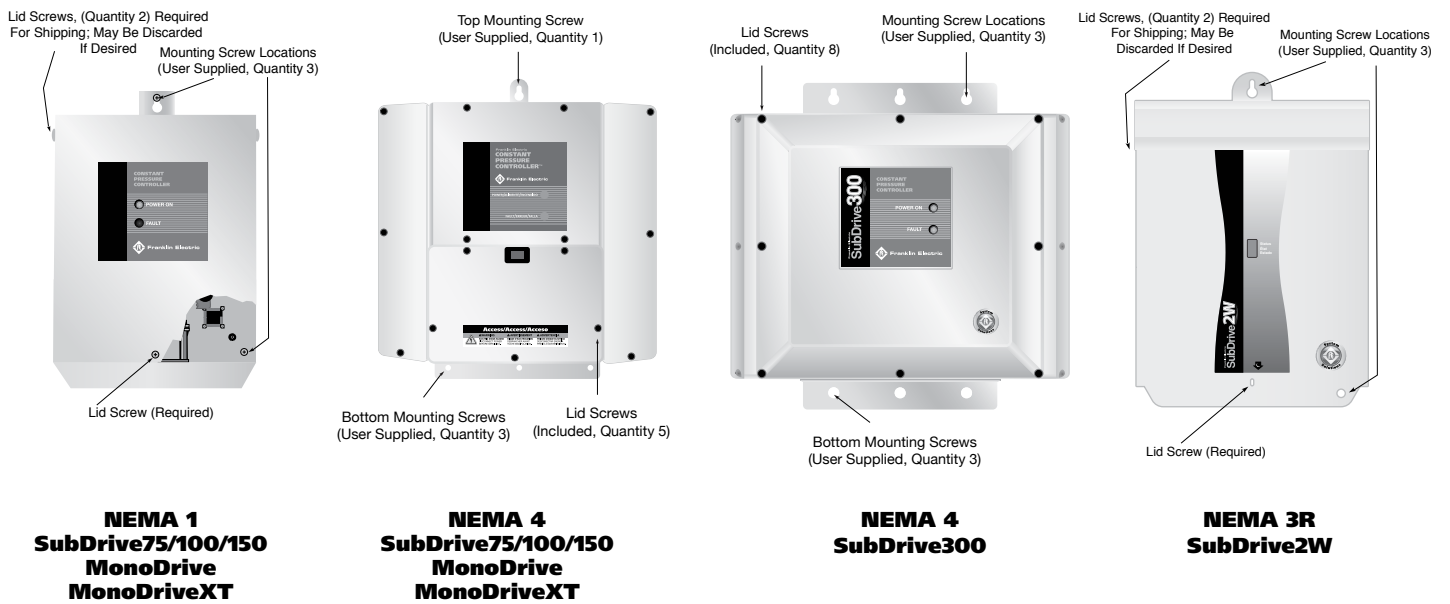

Wiring Connections

⚠ WARNING

Serious or fatal electrical shock may result from failure to connect the motor, the SubDrive/ MonoDrive, metal plumbing and all other metal near the motor, or cable to the power supply ground terminal, using wire no smaller than motor cable wires. To reduce risk of electrical shock, disconnect power before working on or around the water system. Do not use motor in swimming areas.

1. Verify that the power has been shut off at the main breaker.
2. Verify that the dedicated branch circuit for the SubDrive/MonoDrive is equipped with a properly-sized circuit breaker. (See Table 2, pg. 28 for minimum breaker size.)
3. Use appropriate strain relief or conduit connectors. For NEMA 4, Type B liquid-tight fittings are recommended for maximum weather protection.
4. Remove the SubDrive/MonoDrive lid.
5. Feed the motor leads through the opening on the bottom right side of the unit and connect them to the terminal block positions marked GND (Green Ground Wire), Red, Yellow and Black (Figure 3).

Figure 3: Motor Lead Connections

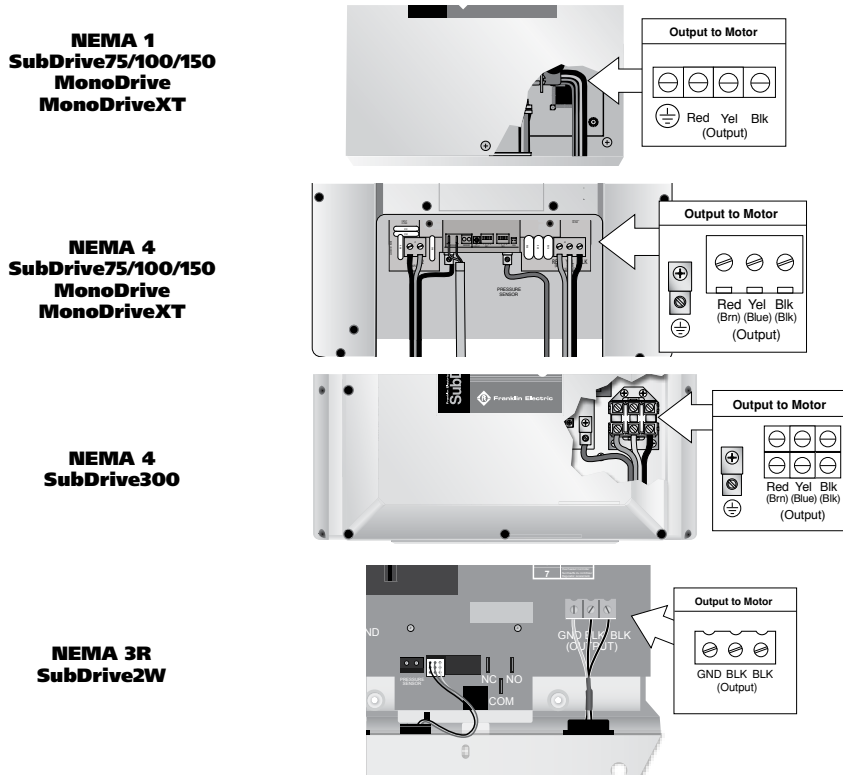

⚠ CAUTION

For retrofit application (i.e. MonoDrive), make sure to check integrity of power and motor leads. This requires measuring the insulation resistance with the suitable megohmmeter.

SubDrive/MonoDrive

Figure 4: Power and Pressure Sensor Connections

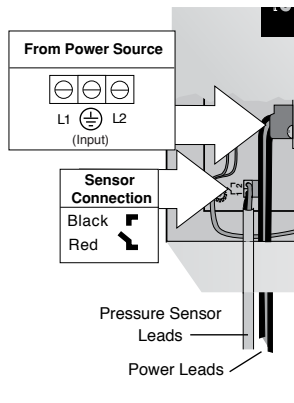

**NEMA 1
SubDrive75/100/150
MonoDrive
MonoDriveXT**

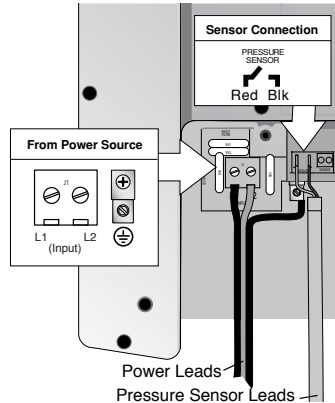

**NEMA 4
SubDrive75/100/150
MonoDrive
MonoDriveXT**

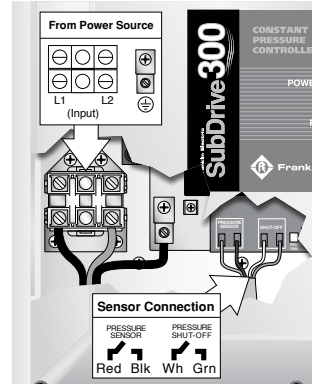

**NEMA 4
SubDrive300**

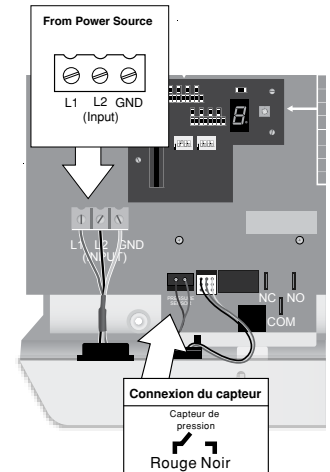

**NEMA 3R
SubDrive2W**

6. Feed the 230 VAC power leads through the larger opening on the bottom left side of the SubDrive/MonoDrive controller and connect them to the terminals marked L1, GND, and L2 (Figure 4).

7. For NEMA 1/NEMA 3R pressure sensor leads, use the smaller opening on the bottom left side of the SubDrive/MonoDrive unit and connect the red and black leads to the terminals marked “1” and “2” (interchangeable) with a small screwdriver (provided). For NEMA 4 pressure sensor leads, either use input power lead opening or optional knock-outs.

Note: A 10-foot (3 m) section of pressure sensor cable is provided with the controller, but it is possible to use similar 22 AWG wire for distances up to 100 feet (30 m) from the pressure sensor. A 100-foot (30 m) section of pressure sensor cable is available from your local Franklin Electric distributor. (See Accessories section for details pg. 44.)

8. Verify that the SubDrive/MonoDrive unit is properly configured for the horsepower rating of the motor and pump being used. (See the section on Pump Sizing for information on Drive Configuration pg. 9-15.)

9. Replace the cover. Do not over-tighten the screw.

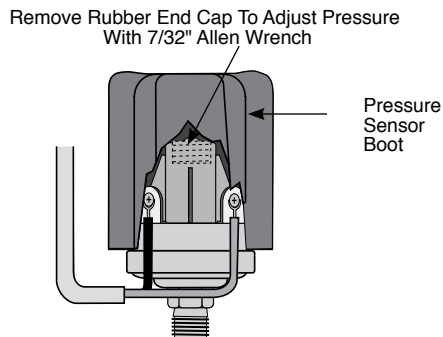

**Figure 5A: Pressure Sensor
(NSF61 rated)**

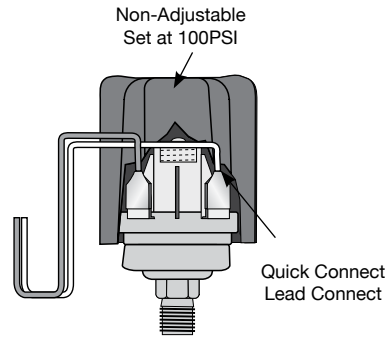

**Figure 5B: Pressure Shut-off Switch
(NSF61 rated)**

10. Connect the other end of the pressure sensor cable with the two spade terminals to the pressure sensor. The connections are interchangeable (Figure 5A).
11. Set the pressure tank pre-charge at 70% of the desired water pressure setting. To check the tank's pre-charge, de-pressurize the water system by opening a tap. Measure the tank pre-charge with a pressure gauge at its inflation valve and make the necessary adjustments.
12. The pressure sensor communicates the system pressure to the SubDrive/MonoDrive controller. The sensor is preset at the factory to 50 psi (3.4 bar), but can be adjusted by the installer using the following procedure:
 - a. Remove the rubber end-cap (Figure 5A).
 - b. Using a 7/32" Allen-wrench (provided), turn the adjusting screw clockwise to increase pressure and counter-clockwise to decrease pressure. The adjustment range is between 25 and 80 psi (1.7 and 5.5 bar) (1/4 turn = approximately 3 psi (0.2 bar)).
 - c. Replace the rubber end cap.
 - d. Cover the pressure sensor terminals with the rubber boot (not to be placed in direct sunlight) provided (Figure 5A).
13. Applies to SubDrive300 only. Connect the sensor end of the pressure sensor cable with the two 1/4" quick connect terminals to the pressure shut-off switch. The connections are interchangeable (Figure 5B).

⚠ CAUTION

When increasing the pressure, do not exceed the mechanical stop on the pressure sensor or 80 psi (5.5 bar). The pressure sensor may be damaged.

NOTE: Ensure that the system is properly grounded all the way to the service entrance panel. Improper grounding may result in the loss of voltage surge protection and interference filtering.

SubDrive/MonoDrive

Special Instructions for Outdoor Installation

SubDrive and MonoDrive controllers with NEMA 4 enclosures are suitable for outdoor use. Special considerations apply for proper operation in outdoor installations. Please observe the following additional installation procedures:

Installation Procedures for NEMA 4

To assure maximum weather protection, the unit must be mounted vertically with the cover properly aligned and secured as described below. Use appropriate weather-tight conduit fittings to maintain NEMA 4 rating.

When replacing the cover, tighten all cover screws for maximum weather resistance.

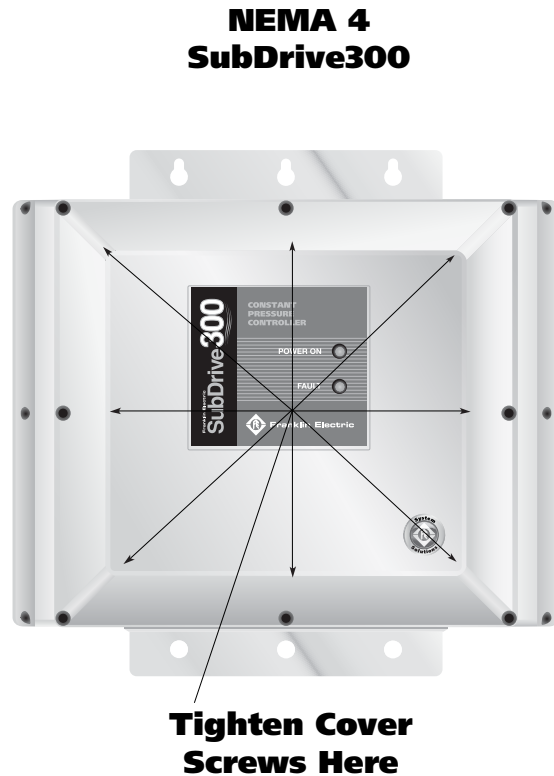

Strain Relief Installation

The SubDrive/Monodrives are to be installed per all applicable electrical codes. When NEMA 4 conduit fittings are not required, use the included liquid-tight strain relief when installing the pressure sensor cable through the holes on the bottom side of the NEMA 4 enclosure.

In order to maintain the liquid-tight rated integrity of the drive enclosure the following torque specifications must be followed:
Locking Nut: 40 – 45 in-lbs (4.52 – 5.08 N-m) Sealing Nut: 50 – 55 in-lbs (5.65 – 6.21 N-m)

SubDrive300

- Install the strain relief body and locking nut through the left-most small port on the bottom side of the enclosure. See FIGURE 6 and FIGURE 7 below.
- Feed the pressure sensor cable through the sealing nut and then through the strain relief body. Connect the pressure sensor quick-connects to the drive circuit board prior to tightening the sealing nut.

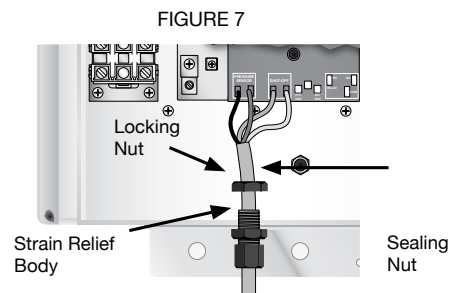
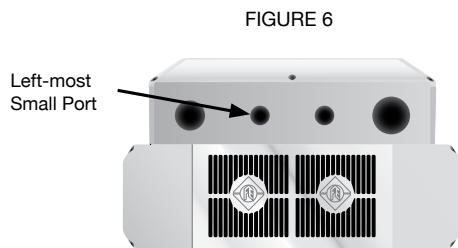

SubDrive75/100/150 and MonoDrive/XT

- Carefully punch out the outermost knockout hole on the bottom side of the drive. See FIGURE 8 below.
- Install the strain relief body and locking nut as shown in FIGURE 9 below.
- Feed the pressure sensor cable through the sealing nut and then through the strain relief body. Connect the pressure sensor quick-connects to the drive circuit board prior to tightening the sealing nut.

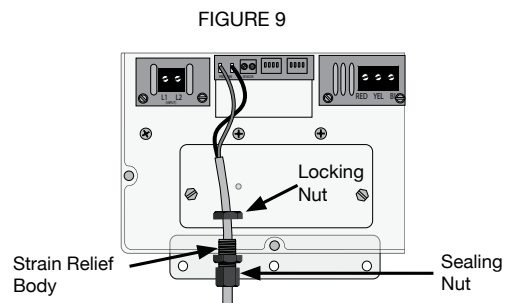
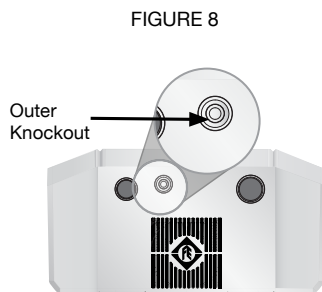

SubDrive/MonoDrive

Start-Up and Operation

Apply power to the controller. A steady green light indicates that the SubDrive/MonoDrive has power but the pump is not running. The green light will flash continuously when the pump is running.

Leaky Systems

Leaky water systems might keep the controller running due to the accurate pressure sensing capability of the pressure sensor. Continuous running or starts and stops do not hurt the controller, pump or motor. However, to reduce the on-time of the controller/pump/motor, a “Bump-Mode” procedure is installed. During low flow (or leaky) conditions, this feature periodically increases the speed of the pump several psi above the set point and shuts off the pump. This adds some time to bleed off before the system starts up again.

NOTE:

Conventional private water systems intermittently fill a pressure tank as commanded by a standard pressure switch (e.g. 30 - 50 psi (2.07 - 3.4 bar)). The SubDrive/MonoDrive maintains a constant pressure at the pressure sensor up to the maximum capability of the motor and pump.

Although the pressure is constant at the pressure sensor, pressure drops may be noticeable in other areas of the home when additional taps are opened. This is due to restrictions in the plumbing and will be more pronounced the farther the taps are from the pressure sensor. This would be true of any system, and if observed, should not be interpreted as a failure in the performance of the SubDrive/MonoDrive.

Specifications – MonoDrive/MonoDriveXT

	MonoDrive	MonoDriveXT	
Model No.	NEMA 1 (indoor)	587 020 3110	587 020 4110
	NEMA 3R (indoor/outdoor)	Not Available	Not Available
	NEMA 4 (outdoor)	587 020 3114	587 020 4114
Input from Power Source	Voltage	190-260 VAC	190-260 VAC
	Phase In	Single-Phase	Single-Phase
	Frequency	60/50 Hz	60/50 Hz
	Current (max)	5.7 Amps (RMS) 1/2 hp, 0.37 kW system 8.7 Amps (RMS) 3/4 hp, 0.55 kW system 11 Amps (RMS) 1 hp, 0.75 kW system	13 Amps (RMS) 1.5 hp, 1.1 kW system 16 Amps (RMS) 2 hp, 1.5 kW system
	Power Factor	1.0 (constant)	1.0 (constant)
	Power (idle)	35 Watts	65 Watts
	Power (max)	1150 Watts (1/2 hp, 0.37 kW) system 1750 Watts (3/4 hp, 0.55 kW) system 2150 Watts (1 hp, 0.75 kW) system	2500 Watts (1.5 hp, 1.1 kW) system 3100 Watts (2 hp, 1.5 kW) system
	Wire Gauge Size(s)	Consult Federal, State, and Local codes for branch circuits installations	Consult Federal, State, and Local codes for branch circuits installations
	Output to Motor	Voltage	Adjusts with Frequency
Phase Out		Single-Phase (3-wire)	Single-Phase (3-wire)
Frequency Range		30-60 Hz	30-60 Hz
Current (max)		Main Phase: 6 Amps (RMS) 1/2 hp, 0.37 kW system Main Phase: 8 Amps (RMS) 3/4 hp, 0.55 kW system Main Phase: 10.4 Amps (RMS) 1 hp, 0.75 kW system	Main Phase: 11.5 Amps (RMS) 1.5 hp, 1.1 kW system Main Phase: 13.2 Amps (RMS) 2 hp, 1.5 kW system
Wire Gauge Size(s)		NEMA 1 #10 - #16 * ga. NEMA 4 #6 - #18 * ga.	NEMA 1 #6 - #18 * ga. NEMA 4 #6 - #18 * ga.
Pressure Setting	Factory Preset	50 psi (3.4 bar)	50 psi (3.4 bar)
	Adjustment Range	25-80 psi (1.7 - 5.5 bar)	25-80 psi (1.7 - 5.5 bar)
Operating Conditions ^(A)	Temperature (at 230 VAC input)	-13 °F to 125 °F (-25 °C to 50 °C)	-13 °F to 125 °F (-25 °C to 50 °C)
	Relative Humidity (NEMA 1)	10-95%, non-condensing	10-95%, non-condensing
	Relative Humidity (NEMA 3R)	Not Available	Not Available
Controller Size ^(B) (approximate)	NEMA 1 (indoor)	16 1/2" x 12 3/8" x 9" (41.91 x 31.43 x 22.86 cm) 15.00 lbs (6.80 kg)	16 1/2" x 12 3/8" x 9" (41.91 x 31.43 x 22.86 cm) 17.50 lbs (7.94 kg)
	NEMA 3R	Not Available	Not Available
	NEMA 4 (outdoor)	17 1/2" x 16 3/8" x 11 3/8" (44.45 x 41.59 x 28.89 cm) 24.14 lbs (10.95 kg)	17 1/2" x 16 3/8" x 11 3/8" (44.45 x 41.59 x 28.89 cm) 28.32 lbs (12.84 kg)
For Use With ^(C)	Pump (60 Hz)	1/2 hp pump/motor with 214505 - series 3/4 hp pump/motor with 214507 - series [default]	1.5 hp pump/motor with 224300 - series [default] 2 hp pump/motor with 224301 - series
	FE Motor Rating	1 hp pump/motor with 214508 - series	

Notes:

(A) Operating temperature is specified at full output power when installed as described in Controller Location Selection on pg. 22.

(B) Refer to pg. 41 for detailed Mounting Dimensions.

(C) If a pump other than the default rating is used, refer to pgs. 14-15 for Drive Configuration.

* Refer to pg. 28 for detailed Circuit Breaker and Wire Sizing.

SubDrive/MonoDrive

Specifications – SubDrive75/100

	SubDrive75	SubDrive100	
Model No.	NEMA 1 (indoor)	Model 5870203380	Model 5870204100
	NEMA 3R (indoor/outdoor)	Not Available	Not Available
	NEMA 4 (outdoor)	Model 5870203384	Model 5870204104
Input from Power Source	Voltage	190-260 VAC	190-260 VAC
	Phase In	Single-Phase	Single-Phase
	Frequency	60/50 Hz	60/50 Hz
	Current (max)	11 Amps (RMS)	19 Amps (RMS)
	Power Factor	1.0 (constant)	1.0 (constant)
	Power (idle)	35 Watts	65 Watts
	Power (max)	2400 Watts	3800 Watts
	Wire Gauge Size(s)	Consult Federal, State, and Local codes for branch circuits installations	Consult Federal, State, and Local codes for branch circuits installations
Output to Motor	Voltage	Adjusts with Frequency	Adjusts with Frequency
	Phase Out	Three-Phase (3-wire)	Three-Phase (3-wire)
	Frequency Range	30-80 Hz (3/4 hp, 0.55 kW) pump 30-70 Hz (1 hp, 0.75 kW) pump 30-60 Hz (1.5 hp, 1.1 kW) pump	30-80 Hz (1 hp, 0.75 kW) pump 30-70 Hz (1.5 hp, 1.1 kW) pump 30-60 Hz (2 hp, 1.5 kW) pump
	Current (max)	5.9 Amps (RMS, each phase)	8.1 Amps (RMS, each phase)
	Wire Gauge Size(s)	NEMA 1 #10 - #16 * ga. NEMA 4 #6 - #18 * ga.	NEMA 1 #6 - #18 * ga. NEMA 4 #6 - #18 * ga.
	Pressure Setting	Factory Preset	50 psi (3.4 bar)
Adjustment Range		25-80 psi (1.7 and 5.5 bar)	25-80 psi (1.7 - 5.5 bar)
Operating Conditions ^(A)	Temperature (at 230 VAC input)	-13 °F to 125 °F (-25 °C to 50 °C)	-13 °F to 125 °F (-25 °C to 50 °C)
	Relative Humidity (NEMA 1)	10-95%, non-condensing	10-95%, non-condensing
	Relative Humidity (NEMA 3R)	Not Available	Not Available
	Relative Humidity (NEMA 4)	0-100%, condensing	0-100%, condensing
Controller Size ^(B) (approximate)	NEMA 1 (indoor)	16 1/2" x 12 3/8" x 9" (41.91 x 31.43 x 22.86 cm) 15.00 lbs (6.80 kg)	16 1/2" x 12 3/8" x 9" (41.91 x 31.43 x 22.86 cm) 17.50 lbs (7.94 kg)
	NEMA 3R	Not Available	Not Available
	NEMA 4 (outdoor)	17 1/2" x 16 3/8" x 11 3/8" (44.45 x 41.59 x 28.89 cm) 24.14 lbs (10.95 kg)	17 1/2" x 16 3/8" x 11 3/8" (44.45 x 41.59 x 28.89 cm) 28.32 lbs (12.84 kg)
For Use With ^(C)	Pump (60 Hz)	3/4 hp (0.55 kW) [default] 1 hp (0.75 kW) 1.5 hp (1.1 kW)	1 hp (0.75 kW) [default] 1.5 hp (1.1 kW) 2 hp (1.5 kW)
	FE Motor Rating	234514 - series (1.5 hp, 1.1 kW)	234315 - series (2 hp, 1.5 kW)

Notes:

(A) Operating temperature is specified at full output power when installed as described in Controller Location Selection on pg. 22.

(B) Refer to pg. 41 for detailed Mounting Dimensions.

(C) If a pump other than the default rating is used, refer to pgs. 9-10 for Drive Configuration.

* Refer to pg. 28 for detailed Circuit Breaker and Wire Sizing.

Specifications – SubDrive150/300

	SubDrive150	SubDrive300	
Model No.	NEMA 1 (indoor)	Model 5870204150	Not Available
	NEMA 3R (indoor/outdoor)	Not Available	Not Available
	NEMA 4 (outdoor)	Model 5870204154	Model 5870206300
Input from Power Source	Voltage	190-260 VAC	220-260 VAC
	Phase In	Single-Phase	Single-Phase
	Frequency	60/50 Hz	60/50 Hz
	Current (max)	23 Amps (RMS)	36 Amps (RMS)
	Power Factor	1.0 (constant)	1.0 (constant)
	Power (idle)	65 Watts	65 Watts
	Power (max)	4600 Watts	7200 Watts
	Wire Gauge Size(s)	Consult Federal, State, and Local codes for branch circuits installations	Consult Federal, State, and Local codes for branch circuits installations
Output to Motor	Voltage	Adjusts with Frequency	Adjusts with Frequency
	Phase Out	Three-Phase (3-wire)	Three-Phase (3-wire)
	Frequency Range	30-80 Hz (1.5 hp, 1.1 kW) pump 30-70 Hz (2 hp, 1.5 kW) pump 30-60 Hz (3 hp, 2.2 kW) pump	30-80 Hz (3 hp, 2.2 kW) pump 30-70 Hz (5 hp, 3.7 kW) pump
	Current (max)	10.9 Amps (RMS, each phase)	17.8 Amps (RMS, each phase)
	Wire Gauge Size(s)	NEMA 1 #6 - #18 * ga NEMA 4 #6 - #18 * ga.	NEMA 4 #2 - #18 * ga.
Pressure Setting	Factory Preset	50 psi (3.4 bar)	50 psi (3.4 bar)
	Adjustment Range	25-80 psi (1.7 - 5.5 bar)	25-80 psi (1.7 - 5.5 bar)
Operating Conditions ^(A)	Temperature (at 230 VAC input)	-13 °F to 125 °F (-25 °C to 50 °C)	-13 °F to 125 °F (-25 °C to 50 °C)
	Relative Humidity (NEMA 1)	10-95%, non-condensing	N/A
	Relative Humidity (NEMA 3R)	Not Available	Not Available
	Relative Humidity (NEMA 4)	0-100%, condensing	0-100%, condensing
Controller Size ^(B) (approximate)	NEMA 1 (indoor)	16 1/2" x 12 3/8" x 9" (41.91 x 31.43 x 22.86 cm) 17.50 lbs (7.94 kg)	Not Available
	NEMA 3R	Not Available	Not Available
	NEMA 4 (outdoor)	17 1/2" x 16 3/8" x 11 3/8" (44.45 x 41.59 x 28.89 cm) 28.32 lbs (12.84 kg)	19 7/8" x 17 1/2" x 14 1/4" (50.48 x 44.45 x 36.20 cm) 35.15 lbs (15.94 kg)
For Use With ^(C)	Pump (60 Hz)	1.5 hp (1.1 kW) [default] 2 hp (1.5 kW) 3 hp (2.2 kW)	3 hp (2.2 kW) [default] 5 hp (3.7 kW)
	FE Motor Rating	234316 - series (3 hp, 2.2 kW)	234317 - series (5 hp, 3.7 kW)

Notes:

(A) Operating temperature is specified at full output power when installed as described in Controller Location Selection on pg. 22.

(B) Refer to pgs. 41-42 for detailed Mounting Dimensions.

(C) If a pump other than the default rating is used, refer to pgs. 11-12 for Drive Configuration.

* Refer to pg. 28 for detailed Circuit Breaker and Wire Sizing.

SubDrive/MonoDrive

Specifications - SubDrive2W

SubDrive2W		
Model No.	NEMA 1 (indoor)	Not Available
	NEMA 3R (indoor/outdoor)	Model 5870203223
	NEMA 4 (outdoor)	Not Available
Input from Power Source	Voltage	207-260 VAC
	Phase In	Single-Phase
	Frequency	60/50 Hz
	Current (max)	14 Amps (RMS) (For circuit breaker sizing)
	Power Factor	0.7 (approximate)
	Power (idle)	20 Watts
	Power (max)	1900 Watts
	Wire Gauge Size(s)	Consult Federal, State, and Local codes for branch circuits installations
Output to Motor	Voltage	Adjusts with Frequency
	Phase Out	Single-Phase (2-wire)
	Frequency Range	30-60 Hz
	Current (max)	6 Amps (RMS) 1/2 hp, 0.37 kW system 8 Amps (RMS) 3/4 hp, 0.55 kW system 10.4 Amps (RMS) 1 hp, 0.75 kW system
	Wire Gauge Size(s)	NEMA 3R #6 - #18 * ga.
Pressure Setting	Factory preset	50 psi (3.4 bar)
	Adjustment Range	25-80 psi (1.7 - 5.5 bar)
Operating Conditions ^(A)	Temperature (at 230 VAC input)	-13 °F to 125 °F (-25 °C to 50 °C)
	Relative Humidity (NEMA 1)	Not Available
	Relative Humidity (NEMA 3R)	10-95%, non-condensing
Controller Size ^(B) (approximate)	NEMA 1 (indoor)	Not Available
	NEMA 3R	12 1/4" x 16 1/2" x 9" (31.1 x 41.9 x 22.9 cm) 15.0 lbs (6.80 kg)
	NEMA 4 (outdoor)	Not Available
For Use With ^(C)	Pump (60 Hz)	1/2 hp pump/motor with 244505 - series 3/4 hp pump/motor with 244507 - series [default]
	FE Motor Rating	1 hp pump/motor with 244508 - series

Notes:

(A) Operating temperature is specified at full output power when installed as described in Controller Location Selection on pg. 22.

(B) Refer to pg. 43 for detailed Mounting Dimensions.

(C) If a pump other than the default rating is used, refer to pg. 13 for Drive Configuration.

* Refer to pg. 28 for detailed Circuit Breaker and Wire Sizing.

Mounting Dimensions

SubDrive75/100/150/MonoDrive/MonoDriveXT Indoor Enclosure (NEMA 1):

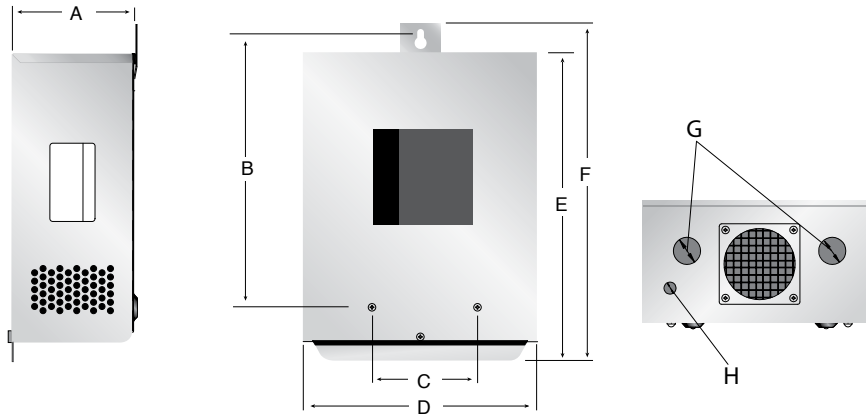

Dimensions in Inches and Centimeters (approximate)

NEMA 1	A	B	C	D	E	F	G	H
Dimension	5.25 (13.34)	11.5 (29.21)	5.5 (13.97)	9.75 (24.77)	12.8 (32.51)	14.0 (35.56)	1.12 (2.85)	0.5 (1.27)
Conduit Sizes	-	-	-	-	-	-	¾ (1.91)	-

SubDrive75/100/150/MonoDrive/MonoDriveXT Outdoor Enclosure (NEMA 4):

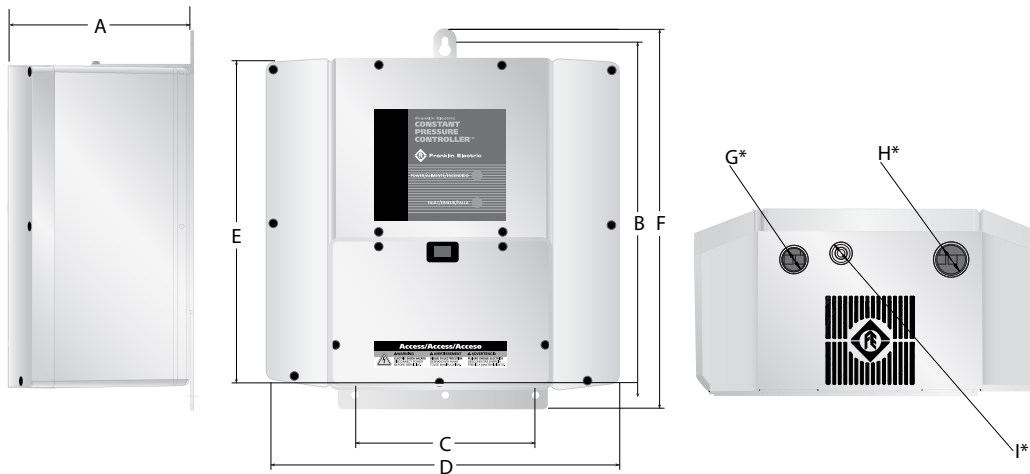

Dimensions in Inches and Centimeters (approximate)

NEMA 4	A	B	C	D	E	F	G*	H*	I*
Dimension	7.25 (18.42)	12.6 (32)	7.0 (17.78)	13.6 (34.54)	12.5 (31.75)	14.8 (37.59)	0.875/ 1.100 (2.79)	1.100/ 1.375 (3.49)	closed/ 0.473 (1.20)
Conduit Sizes	-	-	-	-	-	-	½ (1.27) / ¾ (1.91)	¾ (1.91) / 1 (2.59)	½ (1.27)

* Use knock-outs as required.

SubDrive/MonoDrive

Mounting Dimensions

SubDrive300 Outdoor Enclosure (NEMA 4):

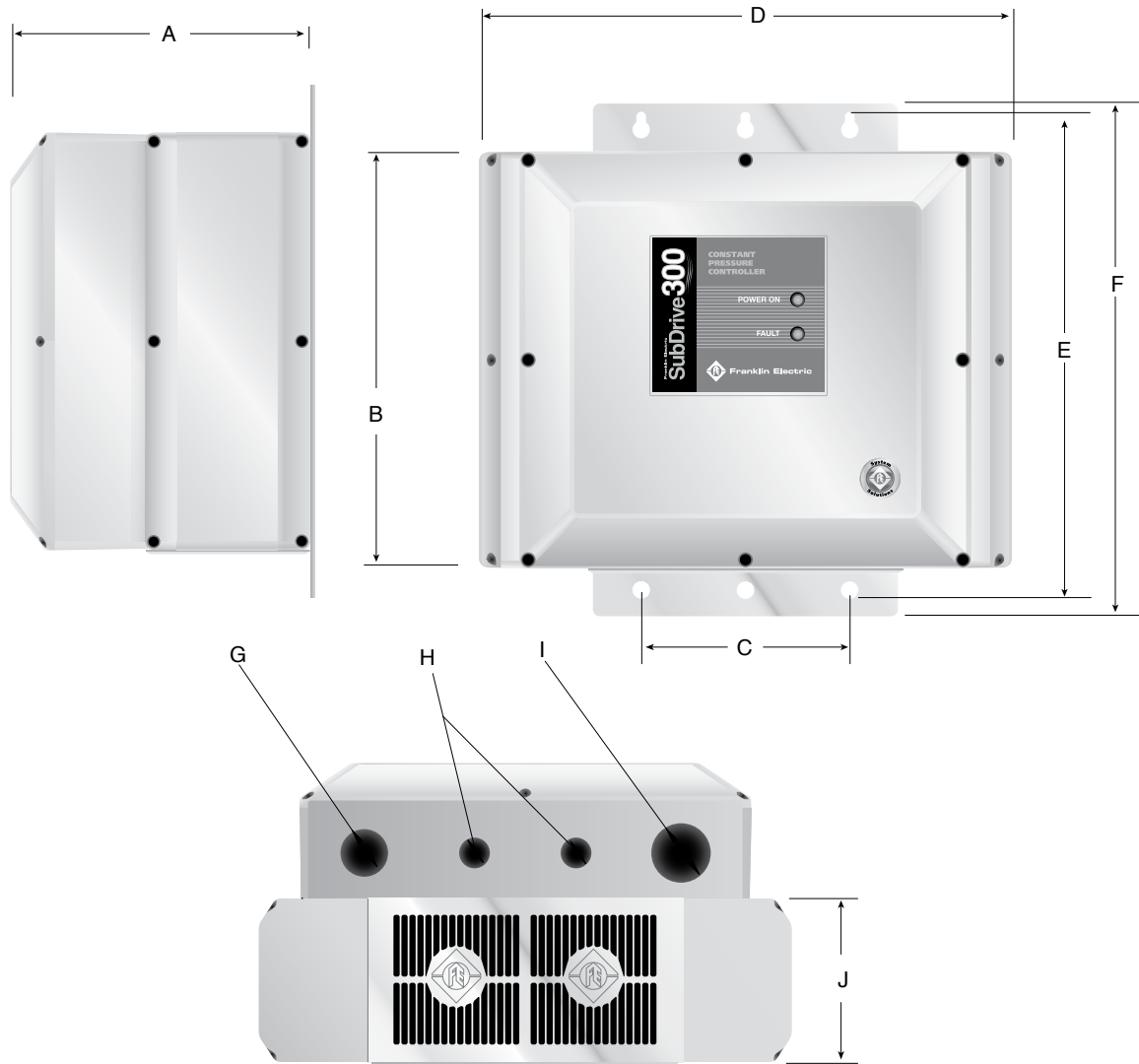

Dimensions in Inches and Centimeters (approximate)

NEMA 4	A	B	C	D	E	F	G	H	I	J
Dimension	8.75 (22.23)	12.00 (30.48)	6.0 (15.24)	15.34 (38.96)	14.00 (35.56)	14.75 (37.47)	1.37 (3.48)	0.885 (2.25)	1.71 (4.34)	4.75 (12.07)
Conduit Size	-	-	-	-	-	-	1 (2.54)	½ (1.27)	¼ (3.18)	-

Mounting Dimensions

SubDrive2W Outdoor Enclosure (NEMA 3R):

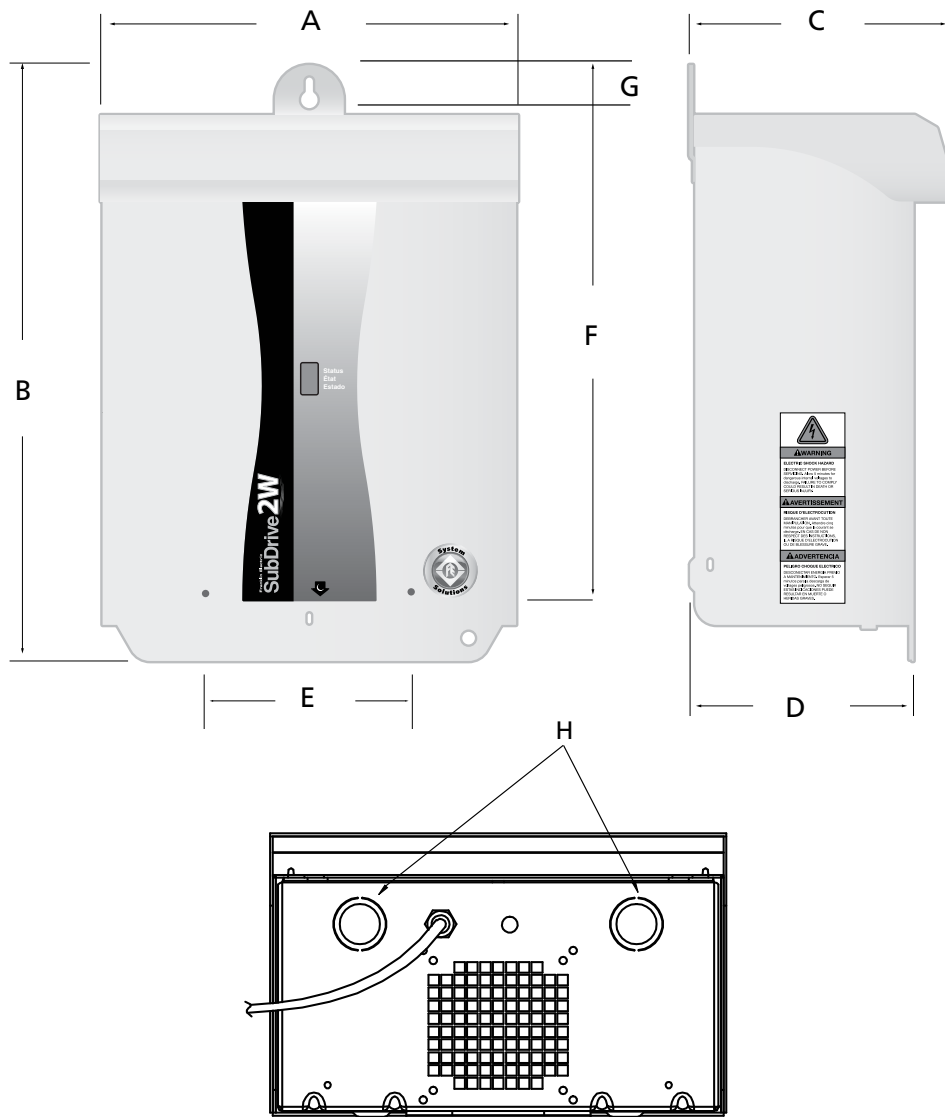

Dimensions in Inches and Centimeters (approximate)

NEMA 3R	A	B	C	D	E	F	G	H*
Dimension	9.91 (25.17)	14.27 (36.25)	6.2 (15.74)	5.25 (13.33)	5.5 (13.97)	11.87 (30.15)	0.44 (1.12)	0.88 (1.13)
Conduit Size	-	-	-	-	-	-	-	1/2 3/4

* Use knock-outs as required.

SubDrive/MonoDrive

Accessories

Accessory	Detail	Used with	Part Number
Air Screen Kit	Assists in preventing insects from entering and damaging the internal components of the drive	SD2W	225 835 901
Duplex Alternator	Allows a water system to alternate between two parallel pumps controlled by separate SubDrives	All Models	585 001 2000
Filter (Input)	Filter used on the input side of drive to help eliminate interference	All Models	225 198 901
Filter (Output)	Filter used on the output side of the drive to help eliminate interference	All Models (excluding SD300)	225 300 901
Filter (System)	Filter used as a system filter on input and output of the drive to help eliminate interference	SD300	225 650 901
Filter (Surge Capacitors)	Capacitor used on the service panel to help eliminate power interference	SD75, SD100, SD150, SD300, MD, MDXT	225 199 901
Heatsink Cover Kit	Assists in preventing critters from entering and blocking fan area	All NEMA 4 models (excluding SD300)	225 805 901
Lightning Arrestor	Single-phase (Input Power)	Single-phase (Input Power)	150 814 902
Low Voltage Kit	Used to make adjustments to the voltage of the SubDrive	SD300	225 950 901
NEMA 1 Fan Replacement Kit	Replacement fan (with Date Code prior to 08L)	SD75 and MD	225 635 905
NEMA 1 Fan Replacement Kit	Replacement fan (with Date Code 08L and after)	SD75 and MD	225 635 908
NEMA 1 Fan Replacement Kit	Replacement fan (with Date Code prior to 08K)	SD100, SD150, and MDXT	225 635 907
NEMA 1 Fan Replacement Kit	Replacement fan (with Date Code 08K and after)	SD100, SD150, and MDXT	225 635 909
NEMA 3R Fan Replacement Kit	Replacement fan (with Date Code prior to 08K)	SD75 and MD	225 635 907
NEMA 3R Fan Replacement Kit	Replacement fan	SD2W	225 635 910
NEMA 4 External Cooling Fan Replacement Kit	Replacement External fan	SD75 and MD	225 635 901
NEMA 4 External Cooling Fan Replacement Kit	Replacement External fan	SD100, SD150 and MDXT	225 635 902
NEMA 4 External Cooling Fan Replacement Kit	Replacement External fan (includes two fans)	SD300	225 635 903
NEMA 4 Internal Stirring Fan Replacement Kit	Replacement Internal Stirring fan	SD75, SD100, SD150, SD300, MD, MDXT	225 635 904
NEMA 4 Auxiliary Relay Board	Offers Run-Indication Relay (with Date Code after 09J)	All NEMA 4 models (excluding SD300)	225 755 901
NEMA 4 Option Card	Offers Run-Indication Relay and Underload Extended Off-Time (with Date Code after 09J)	All NEMA 4 models (excluding SD300)	225 880 901
Pressure Sensor (High: 75-150 psi, NSF 61 rated)	Adjusts pressure in the water system from 75-150 psi (2-leaded cable)	All Models	225 970 901
Pressure Sensor (Standard Replacement: 25-80 psi, NSF 61 rated)	Adjusts pressure in the water system from 25-80 psi (2-leaded cable)	All Models	223 995 901
Pressure Sensor / Pressure Shut-Off Switch Kit	Kit includes pressure sensor (25-80 psi, NSF 61 rated), pressure shut-off switch (100 psi) and 10 feet cable (4-leaded cable)	SD300	225 495 901
Sensor Cable Kit (indoor)	100 feet of 22 AWG cable (2-leaded cable)	SD75, SD100, SD150, MD, and MDXT	223 995 902
Sensor Cable Kit (indoor)	100 feet of 22 AWG cable (4-leaded cable)	SD300	225 495 902
Sensor Direct Burial Cable	Designed to be run in a trench underground without the use of conduit to surround it (4-leaded cable)	All Models - 10 ft (3 m) All Models - 30 ft (9 m) All Models - 100 ft (30.5 m)	225 800 901 225 800 902 225 800 903
Tank Drawdown Kit	Allows the use of water stored in the tank during low flow demands	SD300 and SD2W (Standard)	225 770 901
Tank Drawdown Kit	Allows the use of water stored in the tank during low flow demands	SD75N4, SD100N4, SD150N4, MDN4, and MDXTN4 (requires Auxiliary Relay Board or NEMA 4 Option Card)	225 770 901

Notes

SubDrive/MonoDrive

Notes



DIAGNOSTIC FAULT CODES

NUMBER OF FLASHES	FAULT	POSSIBLE CAUSE	CORRECTIVE ACTION
1	MOTOR UNDERLOAD	<ul style="list-style-type: none"> - Overpumped well - Broken shaft or coupling - Blocked screen, worn pump - Air/gas locked pump - SubDrive not set properly for pump end 	<ul style="list-style-type: none"> - Frequency near maximum with less than 65% of expected load, 42% if DIP #3 is "on" - System is drawing down to pump inlet (out of water) - High static, light loading pump - reset DIP switch #3 to "on" for less sensitivity if not out of water - Check pump rotation (SubDrive only) reconnect if necessary for proper rotation - Air/gas locked pump - if possible, set deeper in well to reduce - Verify DIP switches are set properly
2	UNDERVOLTAGE	<ul style="list-style-type: none"> - Low line voltage - Misconnected input leads - Malfunctioning Fan (NEMA 4 Models) 	<ul style="list-style-type: none"> - Line voltage low, less than approximately 150 VAC (normal operating range = 190 to 260 VAC) - Check incoming power connections and correct or tighten if necessary - Correct incoming voltage - check circuit breaker or fuses, contact power company - For NEMA 4 models, if the incoming voltage has been verified to be OK, the fan may be malfunctioning. Remove power from the drive and wait five (5) minutes for internal voltage to discharge. Remove the Customer Access panel and unplug the fan connector from the control board. Reinstall the customer access panel and reapply power to the drive. If the drive operates normally, replace the fan using the appropriate Fan Replacement Kit (225635902).
3	LOCKED PUMP	<ul style="list-style-type: none"> - Motor and/or pump misalignment - Dragging motor and/or pump - Abrasives in pump 	<ul style="list-style-type: none"> - Amperage above SFL at 10 Hz - Remove and repair or replace as required
4 <small>(MonoDrive & MonoDriveXT only)</small>	INCORRECTLY WIRED	<ul style="list-style-type: none"> - MonoDrive only - Wrong resistance values on main and start 	<ul style="list-style-type: none"> - Wrong resistance on DC test at start - Check wiring, check motor size and DIP switch setting, adjust or repair as needed
5	OPEN CIRCUIT	<ul style="list-style-type: none"> - Loose connection - Defective motor or drop cable - Wrong motor 	<ul style="list-style-type: none"> - Open reading on DC test at start. - Check drop cable and motor resistance, tighten output connections, repair or replace as necessary, use "dry" motor to check drive functions, if drive will not run and exhibits underload fault replace drive
6	SHORT CIRCUIT	<ul style="list-style-type: none"> - When fault is indicated immediately after power-up, short circuit due to loose connection, defective cable, splice or motor 	<ul style="list-style-type: none"> - Amperage exceeded 50 amps on DC test at start or SF amps during running - Incorrect output wiring, phase to phase short, phase to ground short in wiring or motor - If fault is present after resetting and removing motor leads, replace drive
	OVER CURRENT	<ul style="list-style-type: none"> - When fault is indicated while motor is running, over current due to loose debris trapped in pump 	<ul style="list-style-type: none"> - Check pump
7	OVERHEATED DRIVE	<ul style="list-style-type: none"> - High ambient temperature - Direct sunlight - Obstruction of airflow 	<ul style="list-style-type: none"> - Drive heat sink has exceeded max rated temperature, needs to drop below 179 °F to restart - Fan blocked or inoperable, ambient above 125 °F, direct sunlight, air flow blocked - Replace fan or relocate drive as necessary
8 <small>(Subdrive300 only)</small>	OVER PRESSURE	<ul style="list-style-type: none"> - Improper pre-charge - Valve closing too fast - Pressure setting too close to relief valve rating 	<ul style="list-style-type: none"> - Reset the pre-charge pressure to 70% of sensor setting. Reduce pressure setting well below relief valve rating. Use next size larger pressure tank. - Verify valve operation is within manufacturer's specifications. - Reduce system pressure setting to a value less than pressure relief rating.
RAPID	INTERNAL FAULT	<ul style="list-style-type: none"> - A fault was found internal to drive 	<ul style="list-style-type: none"> - Contact your Franklin Electric Service Personnel - Unit may require replacement. Contact your supplier.

Power down, disconnect leads to the motor and power up the SubDrive:

- If the SubDrive does not give an "open phase" fault (5 flashes every 2 seconds), then there is a problem with the SubDrive.
- Connect the SubDrive to a dry motor. If the motor goes through DC test and gives "underload" fault (1 flash every 2 seconds), the SubDrive is working properly.



SUBDRIVE TROUBLESHOOTING

CONDITION	INDICATOR LIGHTS	POSSIBLE CAUSE	CORRECTIVE ACTION
NO WATER	NONE	- No supply voltage present	- If correct voltage is present, replace drive - Verify water pressure is below system set point
	SOLID GREEN	- Pressure sensor circuit	- Jumper wires together at pressure sensor; if pump starts, replace sensor - If pump doesn't start, check sensor connection at printed circuit board (PCB); if loose, repair - If pump doesn't start, jumper sensor connection at PCB; if pump starts, replace wire - If pump doesn't start with sensor PCB connection jumpered, replace drive
	SOLID RED OR SOLID RED AND GREEN	- Power surge, bad component	- Power system down to clear fault, verify voltage, if repetitive, replace drive
PRESSURE FLUCTUATIONS (POOR REGULATION)	FLASHING RED	- Fault detected	- Proceed to fault code description and remedy
	FLASHING GREEN	- Drive and motor are operating - Gulping water at pump inlet	- Frequency max, amps low, check for closed valve, or stuck check valve - Frequency max, amps high, check for hole in pipe - Frequency max, amps erratic, check pump operation, dragging impellers - This is not a drive problem - Check all connections - Disconnect power and allow well to recover for short time, then retry
RUN ON WON'T SHUT DOWN	FLASHING GREEN	- Pressure sensor placement and setting - Pressure gauge placement - Pressure tank size and pre-charge - Leak in system - Air entrainment into pump intake (lack of submergence)	- Correct pressure and placement as necessary - Tank may be too small for system flow - This is not a drive problem - Disconnect power and check pressure gauge for pressure drop - Set deeper in the well or tank; install a flow sleeve with airtight seal around drop pipe and cable - If fluctuation is only on branches before sensor, flip DIP switch #4 to "on" (07C and newer)
	FLASHING RED	- Pressure sensor placement and setting - Tank pre-charge pressure - Impeller damage - Leaky system - Sized improperly (pump can't build enough head)	- Check frequency at low flows, pressure setting may be too close to pump max head - Verify precharge at 70%; if tank size is larger than minimum, increase precharge (up to 85%) - Verify that the system will build and hold pressure
RUNS BUT TRIPS	FLASHING RED	- Check fault code and see corrective action	- Proceed to fault code description and remedy on reverse side
LOW PRESSURE	FLASHING GREEN	- Pressure sensor setting, pump rotation, pump sizing	- Adjust pressure sensor, check pump rotation - Check frequency at max flow, check max pressure
HIGH PRESSURE	FLASHING GREEN	- Pressure sensor setting - Shorted sensor wire	- Adjust pressure sensor - Remove sensor wire at PCB, if drive continues to run, replace drive - Verify condition of sensor wire and repair or replace if necessary
AUDIBLE NOISE	FLASHING GREEN	- Fan, hydraulic, plumbing	- For excessive fan noise, replace fan - If fan noise is normal, drive will need to be relocated to a more remote area - If hydraulic, try raising or lowering depth of pump - Pressure tank location should be at entrance of water line into house
NO LIGHTS	NONE	- Ribbon cable detached from LED printed circuit board	- Reattach cable - if cable is attached, replace drive
RF-EMI INTERFERENCE	FLASHING GREEN	- See interference troubleshooting procedure	