



Models 51, 51-S and 53 Boiler Water Feeders Models 51-2, 51-S-2 and 53-2 Feeder Cut-Off Combinations

OPERATION

Maximum Water Supply Pressure

Models 51/51-2 and 53/53-2: 150 psi (10.5 kg/cm²)

Models 51-S/51-S-2: 100 psi (7 kg/cm²)

Maximum Boiler Pressure

Models 51/51-2 and 51-S/51-S-2: 35 psi (2.5 kg/cm²)

Models 53/53-2: 75 psi (5.3 kg/cm²)

Electrical Ratings

Voltage	Motor Switch Rating (Amperes)		Pilot Duty
	Full Load	Locked Rotor	
120 VAC	10.2	61.2	125 VA at
240 VAC	5.1	30.6	120 or 240 VAC

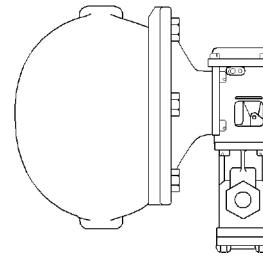

Series 51

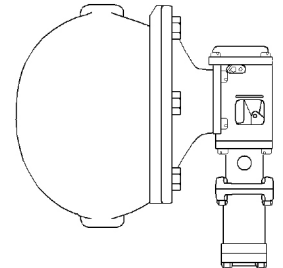

Series 51-S/53

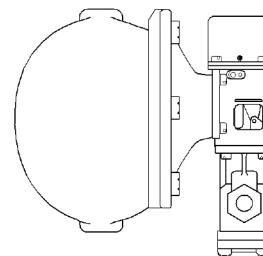

Series 51-2

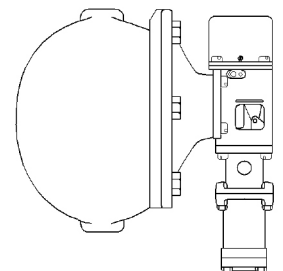

Series 51-S-2/53-2



WARNING



- Before using this product read and understand instructions.
- Save these instructions for future reference.
- All work must be performed by qualified personnel trained in the proper application, installation, and maintenance of plumbing, steam, and electrical equipment and/or systems in accordance with all applicable codes and ordinances.
- To prevent serious burns, the boiler must be cooled to 80°F (27°C) and the pressure must be 0 psi (0 bar) before servicing.
- To prevent electrical shock, turn off the electrical power before making electrical connections.
- This low water cut-off must be installed in series with all other limit and operating controls installed on the boiler. After installation, check for proper operation of all of the limit and operating controls, before leaving the site.
- We recommend that secondary (redundant) Low Water Cut-Off controls be installed on all steam boilers with heat input greater than 400,000 BTU/hour or operating above 15 psi of steam pressure. At least two controls should be connected in series with the burner control circuit to provide safety redundancy protection should the boiler experience a low water condition. Moreover, at each annual outage, the low water cut-offs should be dismantled, inspected, cleaned, and checked for proper calibration and performance.
- Boiler manufacturer schematics should always be followed. In the event that the boiler manufacturer's schematic does not exist, or is not available from the boiler manufacturer, refer to the schematics provided in this document.
- To prevent a fire, do not use this low water cut-off to switch currents over 10.2A, 1/2 Hp at 120 VAC or 5.1A, 1/2 Hp at 240 VAC, unless a starter or relay is used in conjunction with it.

- **California Proposition 65 warning!** This product contains chemicals known to the state of California to cause cancer and birth defects or other reproductive harm.
 - **Previous controls should never be installed on a new system. Always install new controls on a new boiler or system.**
- Failure to follow this warning could cause property damage, personal injury or death.
- CAUTION:**
- **A more frequent replacement interval may be necessary based on the condition of the unit at time of inspection. McDonnell & Miller's warranty is one (1) year from date of installation or two (2) years from the date of manufacture.**

INSTALLATION –

Models 51 / 51-2, Models 51-S / 51-S-2 and Models 53 / 53-2 – For Steam Boilers with 1" (25mm) Equalizing Lines

TOOLS NEEDED:

One (1) flathead screwdriver and two (2) pipe wrenches.

STEP 1 - Determine the Location of the Feeder and/or Low Water Cut-Off

Determine which situation applies:

a. For models 51-2, 51-S-2 or 53-2 on steam boilers:

Always set the control to shut off the burner while there is water visible in the gauge glass. This applies when the gauge glass is directly mounted in the boiler or on a water column.

b. For models 51, 51-S or 53 on steam boilers:

Set the line on the casting $3\frac{1}{8}$ " below the boiler manufacturer's normal water level.

c. For all models on steam process boilers when no

condensate is returned to the boiler: Set the line on the casting $1\frac{1}{8}$ " below the boiler manufacturer's normal water level.

Operating Levels of 51/51-2, 51-S/51-S-2 or 53/53-2

Drip tight valve off	– $1\frac{1}{8}$ "
Casting line	– 0"
Burner on	– $\frac{1}{8}$ " ($\pm \frac{1}{4}$ ")
Burner off	– $\frac{7}{8}$ " ($\pm \frac{1}{4}$ ")

Series 51 and 53 Operating Level

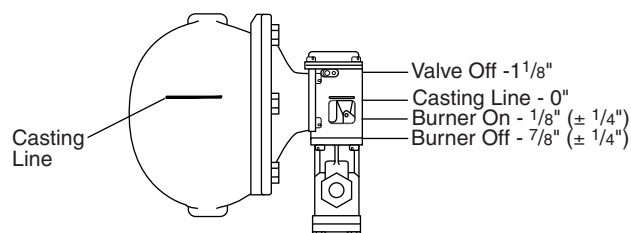

STEP 2 - Installation of the Models 51/51-2, 51-S/51-S-2 and 53/53-2

- a. Using the criteria in Step 1, determine the location of the 51/51-2, 51-S/51-S-2 or 53/53-2. This applies when the gauge glass is directly mounted in the boiler or on a water column.
- b. Use Figure 1 or Figure 2 as a general guide.
- c. Connect steam equalizing lines to any available opening other than steam flow line. (Take off line).

**Figure 1
Gauge Glass Mounted in the Boiler**

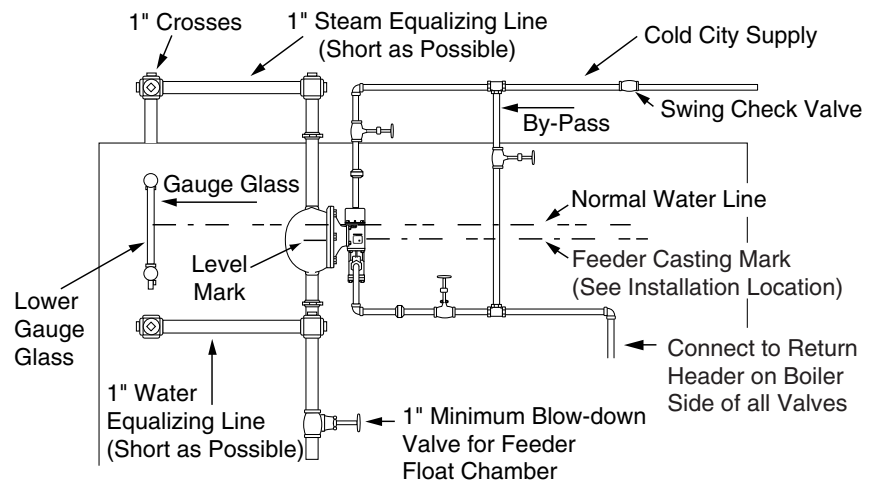

**Figure 2
Gauge Glass Mounted on a Water Column**

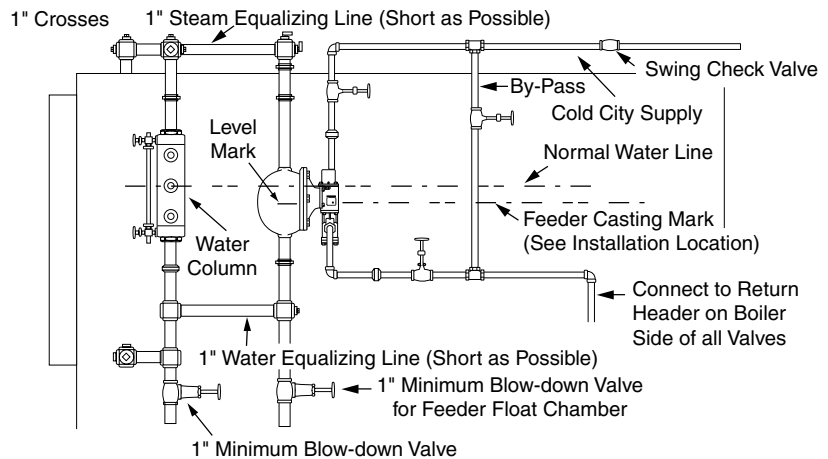

d. Test the Model 51/51-2, 51-S/51-S-2 and 53/53-2 Before Turning it Over to the Owner

Open the blow-down valve while burner is operating. As the water level drops the feeder will begin to add water. As the water continues to drop the burner will shut off (on the 51-2, 51-S-2 and 53-2 only).

INSTRUCTIONS FOR PIPING THE WATER FEEDER VALVE

Models 51 / 51-2, Models 51-S / 51-S-2 and Models 53 / 53-2
For Steam or Hot Water Boilers

TOOLS NEEDED:

Two (2) pipe wrenches.

STEP 1 - Piping the Valve on Models 51/51-2

- a. Follow the drawing to the right for piping the valve to boiler and city water supply. When piping the valve remember to leave room for servicing the valve.

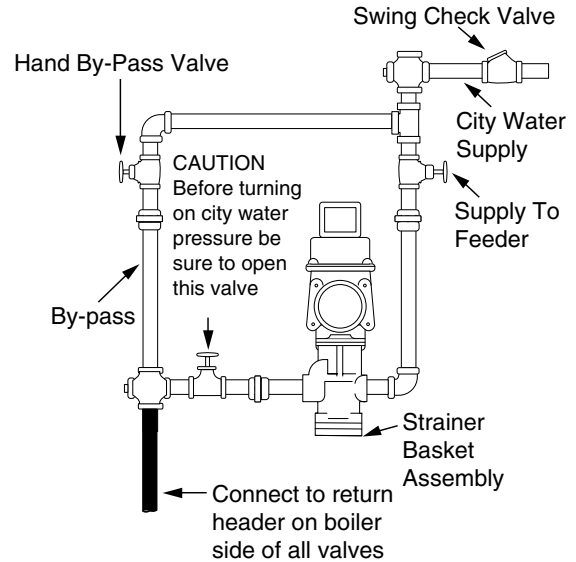

STEP 2 - Piping the Valve on Models 51-S/51-S-2, 53/53-2

- a. Follow the drawing to the right for piping the valve to the boiler and city water supply. When piping the valve remember to leave room for servicing the valve.

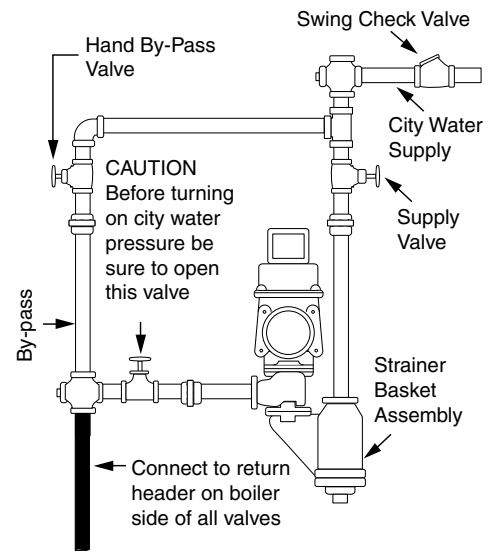

ELECTRICAL WIRING

Models 51-2, 51-S-2 and 53-2

TOOLS NEEDED:

One (1) flathead screwdriver.

WARNING



- To prevent electrical shock, turn off the electrical power before making electrical connections.
- This low water cut-off must be installed in series with all other limit and operating controls installed on the boiler. After installation, check for proper operation of all of the limit and operating controls, before leaving the site.



Failure to follow this warning could cause electrical shock, an explosion and/or a fire, which could result in property damage, personal injury or death.

a. The No. 2 switch can be positioned with the conduit opening facing toward or away from the float chamber. These are the only positions in which the switch will function properly. See drawing at right.

b. On initial fill-up, push the 2M manual reset button after the proper water level is reached to energize the burner. If a low water condition occurs and the water level has been restored, push the reset button to energize the burner.

c. Follow the wiring diagrams below to wire the No. 2 Switch. Terminals C and NC are the low water cut-off switch. Terminals C and NO are alarm switch. If the electrical load exceeds the rating of the switch, use an auxiliary relay or motor starter.

Conduit opening facing toward float chamber

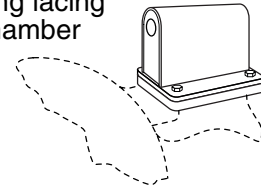

Conduit opening facing away from float chamber

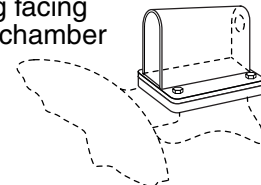

Manual reset button on No. 2m Switch

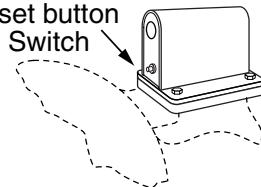

SCHEMATIC OF SWITCH OPERATION

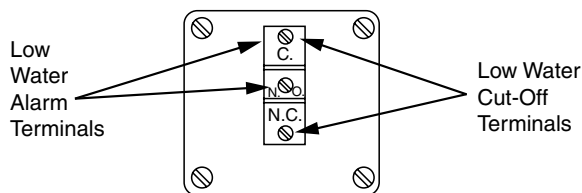

Water Level Normal
Burner On
Alarm Off

Water Level Low
Burner Off
Alarm On

USED AS A MAIN LINE SWITCH AND/OR LOW WATER ALARM

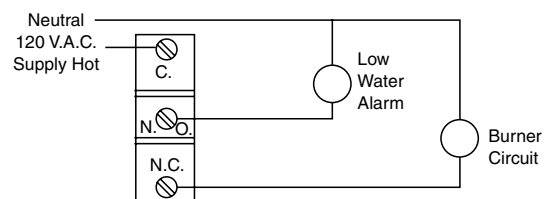

USED AS A PILOT SWITCH TO COIL OF RELAY OR MOTOR STARTER

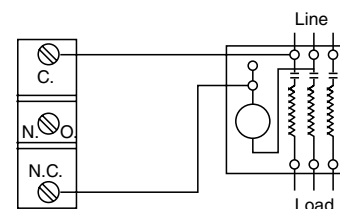

STEP 3 - Testing and Inspection

Blow Down of Feeder

CAUTION



To prevent serious personal injury from steam pipe blow down, connect a drain pipe to the control opening to avoid exposure to steam discharge. Failure to follow this caution could cause personal injury.

The feeder should be blown down after initial installation, before leaving site. It should also be blown down as recommended in the Maintenance section of these instructions.

- Burner should be on and water level above 'closing level' of feeder.
- **Slowly** open the water feeder blow down valve, which will lower the water level in the float chamber. As water flows out the blow down pipe, you should begin to hear the feeder valve open.
- If the feeder has a #2 switch, the burner should stop.
- Close the water feeder blow down valve. The water level should return to a safe operating level and the burner should turn on.

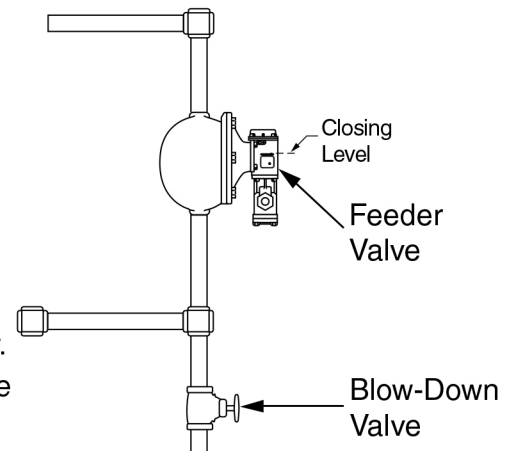

Broken Union Test

Make sure that the water level in the boiler is above the closing level of the feeder.

Close valve 'A' and slowly open union 'B' to determine if valve is leaking.

- If water is leaking from the union, the valve needs to be serviced.
- If no water leaks from the union, the feeder operation is not the cause of the flooding.

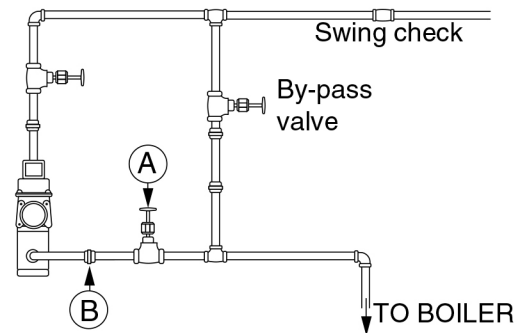

Series 51

Removal of cartridge and strainer for inspection and cleaning

- Using a 1/2" socket wrench, unscrew the four (4) hex-head bolts (B) that secure the strainer basket (H) to the valve assembly (E).
- Using a 13/16" socket wrench, unscrew the cartridge (D) and remove.
- Clean any debris (scale, rust, etc.) from strainer and cartridge. Poppet inside cartridge must move freely. Replace if debris cannot be removed or poppet does not move freely.
- Lubricate cartridge o-rings using silicone type lubricant and re-install.
- Re-install strainer basket.

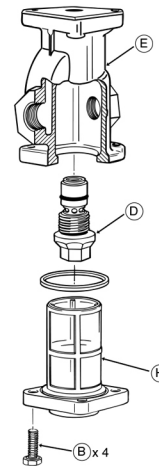

Series 51-S/53

Removal of strainer for inspection and cleaning

- Using a 1/2" wrench, unscrew the four (4) hex-head bolts (B) that secure the strainer.
- Clean any debris (scale, rust, etc.) from strainer. Replace if debris cannot be removed.
- Re-install strainer.

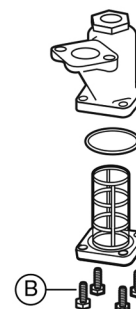

TROUBLESHOOTING

The following is intended as a guide to determine why the feeder may not be operating as intended. Please note that there can be system and installation issues that can affect the operation of the feeder. This includes but is not limited to the following:

- Piping not installed properly
- Faulty check valve in return header
- Tankless coil leaking

Boiler is getting too much water.

a) **Cause:** The valve is not shutting off.

Test: Perform broken union test.

Solution:

- **Series 51 Feeders Only:** Remove and inspect cartridge. Clean or replace as necessary.
- **Series 51-S and 53 Feeders Only:** There may be debris lodged in the valve preventing it from closing completely. Remove and clean valve assembly. Replace if necessary.

b) **Cause:** By-pass valve is leaking.

Test: Perform broken union test.

Solution: Repair or replace valve.

c) **Cause:** Float chamber clogged with sediment.

Test: Open blow-down valve. If there is little or no water flow, the chamber may be clogged with sediment.

Solution: Remove head assembly from float chamber and clean sediment from chamber, float and bellows mechanism. Replace head mechanism if necessary.

d) **Cause:** Float has filled with water.

Solution: Replace float.

e) **Cause:** Equalizing piping is plugged.

Solution: Clean or replace piping.

f) **Cause:** City water supply is above 150 psi (51, 53 Feeders) or 100 psi (51-S Feeder).

Solution: Install pressure reducing valve to reduce water pressure.

Unit is making noise.

(Series 51 Feeders Only)

a) **Cause:** Under certain system conditions, there may be a vibration when the valve mechanism (cartridge poppet) is slightly open.

Solution: Install a pressure reducing valve such as the Bell & Gossett B-38 in the inlet water line before the feeder valve.

Burner switch not working.

a) **Cause:** Cam worn or broken.

Solution: Replace cam assembly (CO-106/302900).

b) **Cause:** Linkages not transferring float movement to switch.

Solution:

- Linkage pins may be worn or broken which would require purchasing a new valve assembly:
 - for 51/51-2: SA51-101-102/342500
 - for 53/53-2: SA53-6/342800
 - for 51-S/51-S-2: SA515-6/342100
- Float may be damaged, sediment may have accumulated in chamber or equalizing piping may be plugged. Perform testing to determine what the problem may be and correct.

- Priming and foaming of boiler water

- Delay in condensate returning to boiler

Boiler is not getting enough water.

a) **Cause:** There is something preventing the valve from fully opening.

Test: Perform broken union test.

Solution:

- **Series 51 Feeders Only:** Remove and inspect cartridge. Clean or replace as necessary.
- **Series 51-S and 53 Feeders Only:** There may be debris lodged in the valve preventing it from closing completely. Remove and clean valve assembly. Replace if necessary.

b) **Cause:** Strainer clogged with sediment.

Test: Perform broken union test.

Solution: Remove and inspect strainer. Clean or replace as necessary.

c) **Cause:** Float chamber clogged with sediment.

Test: Open blow-down valve. If there is little or no water flow, the chamber may be clogged with sediment.

Solution: Remove head assembly from float chamber and clean sediment from chamber, float and bellows mechanism. Replace head mechanism if necessary.

d) **Cause:** Feed line between valve and boiler is partially plugged.

Test: Perform broken union test. With union broken, there should be water flowing through the piping from the boiler.

Solution: Clean or replace piping.

e) **Cause:** Feed line between valve and city water supply is plugged.

Solution: Clean or replace piping.

f) **Cause:** Water supply pressure less than boiler pressure.

Solution: Reduce boiler pressure or convert to pumped return.

Water leaking from bellows

a) **Cause:** Continuous exposure to chemicals with pH higher than 9.0 will cause the solder to deteriorate.

Solution: Remove source of chemicals or consider replacing control with one that is suitable for the application.

MAINTENANCE

SCHEDULE:

Daily

- Blow down when boiler is in operation if boiler operating pressure is above 15 psi.

Weekly

- Blow down when boiler is in operation if boiler operating pressure is below 15 psi.

Annually

- **Disassemble and inspect/clean strainer screen.** Replace if screen is torn or not able to be cleaned.
- **Remove and inspect/clean cartridge. (For Series 51 Feeders Only).** Replace if poppet does not move freely or debris cannot be removed.
- **Remove head and inspect internal parts.** Clean out all mud, silt, sediment and debris from chamber, float mechanism and other waterside components.
- **Inspect equalizing piping.** Clean or replace as required.
- **Check all wires for brittle or worn insulation.**
- **Check for leaks at gasket surfaces and solder joints.**

COMMERCIAL WARRANTY

Warranty. For goods sold to commercial buyers, Seller warrants the goods sold to Buyer hereunder (with the exception of membranes, seals, gaskets, elastomer materials, coatings and other "wear parts" or consumables all of which are not warranted except as otherwise provided in the quotation or sales form) will be (i) be built in accordance with the specifications referred to in the quotation or sales form, if such specifications are expressly made a part of this Agreement, and (ii) free from defects in material and workmanship for a period of one (1) year from the date of installation or two (2) years from the date of manufacture, whichever shall occur first, unless a longer period is specified in the product documentation (the "Warranty").

Except as otherwise required by law, Seller shall, at its option and at no cost to Buyer, either repair or replace any product which fails to conform with the Warranty provided Buyer gives written notice to Seller of any defects in material or workmanship within ten (10) days of the date when any defects or non-conformance are first manifest. Under either repair or replacement option, Seller shall not be obligated to remove or pay for the removal of the defective product or install or pay for the installation of the replaced or repaired product and Buyer shall be responsible for all other costs, including, but not limited to, service costs, shipping fees and expenses. Seller shall have sole discretion as to the method or means of repair or replacement. Buyer's failure to comply with Seller's repair or replacement directions shall terminate Seller's obligations under this Warranty and render the Warranty void. Any parts repaired or replaced under the Warranty are warranted only for the balance of the warranty period on the parts that were repaired or replaced. Seller shall have no warranty obligations to Buyer with respect to any product or parts of a product that have been: (a) repaired by third parties other than Seller or without Seller's written approval; (b) subject to misuse, misapplication, neglect, alteration, accident, or physical damage; (c) used in a manner contrary to Seller's instructions for installation, operation and maintenance; (d) damaged from ordinary wear and tear, corrosion, or chemical attack; (e) damaged due to abnormal conditions, vibration, failure to properly prime, or operation without flow; (f) damaged due to a defective power supply or improper electrical protection; or (g) damaged resulting from the use of accessory equipment not sold or approved by Seller. In any case of products not manufactured by Seller, there is no warranty from Seller; however, Seller will extend to Buyer any warranty received from Seller's supplier of such products.

THE FOREGOING WARRANTY IS EXCLUSIVE AND IN LIEU OF ANY AND ALL OTHER EXPRESS OR IMPLIED WARRANTIES, GUARANTEES, CONDITIONS OR TERMS OF WHATEVER NATURE RELATING TO THE GOODS PROVIDED HEREUNDER, INCLUDING WITHOUT LIMITATION ANY IMPLIED WARRANTIES OF MERCHANTABILITY AND FITNESS FOR A PARTICULAR PURPOSE, WHICH ARE HEREBY EXPRESSLY DISCLAIMED AND EXCLUDED. EXCEPT AS OTHERWISE REQUIRED BY LAW, BUYER'S EXCLUSIVE REMEDY AND SELLER'S AGGREGATE LIABILITY FOR BREACH OF ANY OF THE FOREGOING WARRANTIES ARE LIMITED TO REPAIRING OR REPLACING THE PRODUCT AND SHALL IN ALL CASES BE LIMITED TO THE AMOUNT PAID BY THE BUYER FOR THE DEFECTIVE PRODUCT. IN NO EVENT SHALL SELLER BE LIABLE FOR ANY OTHER FORM OF DAMAGES, WHETHER DIRECT, INDIRECT, LIQUIDATED, INCIDENTAL, CONSEQUENTIAL, PUNITIVE, EXEMPLARY OR SPECIAL DAMAGES, INCLUDING BUT NOT LIMITED TO LOSS OF PROFIT, LOSS OF ANTICIPATED SAVINGS OR REVENUE, LOSS OF INCOME, LOSS OF BUSINESS, LOSS OF PRODUCTION, LOSS OF OPPORTUNITY OR LOSS OF REPUTATION.

LIMITED CONSUMER WARRANTY

Warranty. For goods sold for personal, family or household purposes, Seller warrants the goods purchased hereunder (with the exception of membranes, seals, gaskets, elastomer materials, coatings and other "wear parts" or consumables all of which are not warranted except as otherwise provided in the quotation or sales form) will be free from defects in material and workmanship for a period of one (1) year from the date of installation or two (2) years from the product date code, whichever shall occur first, unless a longer period is provided by law or is specified in the product documentation (the "Warranty").

Except as otherwise required by law, Seller shall, at its option and at no cost to Buyer, either repair or replace any product which fails to conform with the Warranty provided Buyer gives written notice to Seller of any defects in material or workmanship within ten (10) days of the date when any defects or non-conformance are first manifest. Under either repair or replacement option, Seller shall not be obligated to remove or pay for the removal of the defective product or install or pay for the installation of the replaced or repaired product and Buyer shall be responsible for all other costs, including, but not limited to, service costs, shipping fees and expenses. Seller shall have sole discretion as to the method or means of repair or replacement. Buyer's failure to comply with Seller's repair or replacement directions shall terminate Seller's obligations under this Warranty and render this Warranty void. Any parts repaired or replaced under the Warranty are warranted only for the balance of the warranty period on the parts that were repaired or replaced. The Warranty is conditioned on Buyer giving written notice to Seller of any defects in material or workmanship of warranted goods within ten (10) days of the date when any defects are first manifest.

Seller shall have no warranty obligations to Buyer with respect to any product or parts of a product that have been: (a) repaired by third parties other than Seller or without Seller's written approval; (b) subject to misuse, misapplication, neglect, alteration, accident, or physical damage; (c) used in a manner contrary to Seller's instructions for installation, operation and maintenance; (d) damaged from ordinary wear and tear, corrosion, or chemical attack; (e) damaged due to abnormal conditions, vibration, failure to properly prime, or operation without flow; (f) damaged due to a defective power supply or improper electrical protection; or (g) damaged resulting from the use of accessory equipment not sold or approved by Seller. In any case of products not manufactured by Seller, there is no warranty from Seller; however, Seller will extend to Buyer any warranty received from Seller's supplier of such products.

THE FOREGOING WARRANTY IS PROVIDED IN PLACE OF ALL OTHER EXPRESS WARRANTIES. ALL IMPLIED WARRANTIES, INCLUDING BUT NOT LIMITED TO THE IMPLIED WARRANTIES OF MERCHANTABILITY AND FITNESS FOR A PARTICULAR PURPOSE, ARE LIMITED TO ONE (1) YEAR FROM THE DATE OF INSTALLATION OR TWO (2) YEARS FROM THE PRODUCT DATE CODE, WHICHEVER SHALL OCCUR FIRST. EXCEPT AS OTHERWISE REQUIRED BY LAW, BUYER'S EXCLUSIVE REMEDY AND SELLER'S AGGREGATE LIABILITY FOR BREACH OF ANY OF THE FOREGOING WARRANTIES ARE LIMITED TO REPAIRING OR REPLACING THE PRODUCT AND SHALL IN ALL CASES BE LIMITED TO THE AMOUNT PAID BY THE BUYER FOR THE DEFECTIVE PRODUCT. IN NO EVENT SHALL SELLER BE LIABLE FOR ANY OTHER FORM OF DAMAGES, WHETHER DIRECT, INDIRECT, LIQUIDATED, INCIDENTAL, CONSEQUENTIAL, PUNITIVE, EXEMPLARY OR SPECIAL DAMAGES, INCLUDING BUT NOT LIMITED TO LOSS OF PROFIT, LOSS OF ANTICIPATED SAVINGS OR REVENUE, LOSS OF INCOME, LOSS OF BUSINESS, LOSS OF PRODUCTION, LOSS OF OPPORTUNITY OR LOSS OF REPUTATION.

Some states do not allow limitations on how long an implied warranty lasts, so the above limitation may not apply to you. Some states do not allow the exclusion or limitation of incidental or consequential damages, so the above exclusions may not apply to you. This warranty gives you specific legal rights, and you may also have other rights which may vary from state to state.

To make a warranty claim, check first with the dealer from whom you purchased the product or call +1-847-966-3700 for the name and location of the nearest dealer providing warranty service.

xylem
Let's Solve Water

Xylem Inc.
8200 N. Austin Avenue
Morton Grove, Illinois 60053
Phone: (847) 966-3700
Fax: (847) 965-8379
www.mcdonnellmiller.com

McDonnell & Miller is a trademark of Xylem Inc. or one of its subsidiaries.
© 2015 Xylem Inc. MM-315G September 2015 Part No. 210424

NOTE

Use clean water to rinse components and surfaces. DO NOT use sharp objects to scrape off any accumulations of sediment or debris.

Replace entire unit including equalizing piping every 10 years.

More frequent cleaning or replacement may be required if used in locations where water treatment is required or in applications with high make-up water requirements.

